

Parallel Systems

A Few Words About the Lecture Organization

Parallel Systems

A. Legrand

Killer applications

Computers must
be Parallel

Moore
Power Saving
Memory Limit
Conclusion

Concurrency
Within a CPU

Pipelining
ILP
Vector Units
Multi-Threading

Concurrency
Within a Box
SMP
Multi-cores
Accelerators:
GPU

Concurrency
Across Boxes
Clusters
What next?

Two lecturers

- ▶ Arnaud Legrand, CNRS, INRIA MESCAL project.
- ▶ Vincent Danjean, UJF, INRIA MOAIS project.

Eleven 3-hours lectures (tentative roadmap)

- ▶ Parallel Architectures [24 sep] (A. Legrand)
- ▶ Parallel algorithms [1 Oct] (A. Legrand)
- ▶ High Performance Networks. How to Efficiently Program High Performance Architectures? [8,15 oct] (V. Danjean)
- ▶ Parallel algorithms and models [22 oct, 5 nov] (A. Legrand)
- ▶ From parallelism-aware algorithms to parallelism-oblivious algorithm [12, 19 nov] (V. Danjean)
- ▶ Hype and trends, desktop grids, clouds [26 nov, 3, 10 dec] (A. Legrand)
- ▶ Step-by-step exam [monday afternoon in nov/dec ?]
- ▶ Exam [end jan]

Parallel Systems

A Few Words About What We Expect From You

Parallel Systems

A. Legrand

Killer applications

Computers must
be Parallel

Moore

Power Saving
Memory Limit

Conclusion

Concurrency
Within a CPU

Pipelining
ILP

Vector Units

Multi-Threading

Concurrency
Within a Box

SMP

Multi-cores

Accelerators:
GPU

Concurrency
Across Boxes

Clusters

What next?

- ▶ The content of this lecture is rather **dense** and is intended to give you a broad overview of this area.
- ▶ No real need to read books. The slides comprise all the material you need, which is why there are so many.
- ▶ Many of the comments we do are very general and will be enlightening only if you spend time trying to figure out the whole picture.
- ▶ You cannot reasonably expect to have understood everything at the end of the slides.

1 hour of lecture = at least 1 hour of personal work to re-read and understand the corresponding slides

- ▶ At the beginning of each lecture, you will thus certainly have questions about last lecture.
If not. . . well, nevermind, it probably means the lectures were crystal clear although I doubt it.

Parallel Systems

Communication

Parallel Systems

A. Legrand

Killer applications

Computers must
be Parallel

Moore

Power Saving

Memory Limit

Conclusion

Concurrency
Within a CPU

Pipelining

ILP

Vector Units

Multi-Threading

Concurrency
Within a Box

SMP

Multi-cores

Accelerators:
GPU

Concurrency
Across Boxes

Clusters

What next?

- ▶ There is a website with all the slides as well as practical information (room location, roadmap, additional readings, homeworks).

http://mescal.imag.fr/membres/arnaud.legrand/teaching/2012/M2R_PC.php

- ▶ If you have a question:

<mailto:arnaud.legrand@imag.fr> <mailto:vincent.danjean@imag.fr>

The basic requirements for following this lecture are: Operating Systems, Networking and Algorithms.

- ▶ The mailing list should be set up today. I will send you a very short survey to estimate your current knowledge and background on parallel computing, OS, networking and algorithms.
- ▶ You should create an account on Grid5000 (“get an account”, fill the form with my name as responsible for you):

<https://www.grid5000.fr/>

The M2R is not an exam. It is a contest.

There are few grants. You work to prepare yourself to a career in research.

- ▶ The Performance Evaluation lecture is **extremely** important.
- ▶ Bring your lunch for **Tuesday's brown bag lunch session**.
 - ▶ Tuesday from 11:45 to 13:15 for 4-5 weeks.
 - ▶ Tomorrow, brief intro to critical thinking, scientific rigor and plagiarism. Then, we teach you how to work on articles.
 - ▶ Two articles per week that everyone has to read and be ready to brainstorm about it.
 - ▶ Each group is assigned one of the paper and has to prepare a 20 minute presentation.
 - ▶ The week after, we pick a group at random for each article and everyone provides feedback to the presentation.
- ▶ The list of internship proposals is here:

<http://projets-mastermi.imag.fr/pcarre/>

I will soon give you a brief presentation of the three teams **MESCAL**, **MOAIS** and **NANOSIM**.

What is Parallel Computing?

- **Parallel computing:** using multiple processors/cores in parallel to solve problems more quickly than with a single processor/core
- Examples of parallel machines:
 - A **Chip Multi-Processor** (CMP) contains multiple processors (called cores) on a single chip
 - A **shared memory multiprocessor** (SMP*) by connecting multiple processors to a single memory system
 - A **cluster computer** that contains multiple PCs combined together with a high speed network
 - A **grid** is a cluster of networked, loosely-coupled computers acting to perform very large tasks
- **Concurrent execution** comes from desire for **performance**; unlike the inherent concurrency in a multi-user distributed system
- * Technically, SMP stands for “Symmetric Multi-Processor”

Motivations of this first course...

- Details of machine are important for performance
 - Processor, memory system, communication (not just parallelism)
 - Before you parallelize, make sure you're getting good serial performance
 - What to expect? Use understanding of hardware limits
- There is parallelism hidden within processors
 - Pipelining, SIMD, etc
- Locality is at least as important as computation
 - Temporal: re-use of data recently used
 - Spatial: using data nearby that recently used
- Machines have memory hierarchies
 - 100s of cycles to read from DRAM (main memory)
 - Caches are fast (small) memory that optimize average case
- Can rearrange code/data to improve locality

Why Parallel Computing Now?

- Researchers have been using parallel computing for decades:
 - Mostly used in computational science and engineering
 - Problems too large to solve on one computer; use 100s or 1000s
- Many companies in the 80s/90s “bet” on parallel computing and failed
 - Computers got faster too quickly for there to be a large market

Why Parallelism (2008)?

- These arguments are no long theoretical
- All major processor vendors are producing multicore chips
 - Every machine will soon be a parallel machine
 - All programmers will be parallel programmers???
- New software and programming model
 - Want a new feature? Hide the “cost” by speeding up the code first
 - All programmers will be performance programmers???
- Some may eventually be hidden in libraries, compilers, and high level languages
 - But a lot of work is needed to get there
- Big open questions:
 - What will be the killer apps for parallel machines?
 - How should the chips be designed, and how will they be programmed?

Parallel Architectures

Arnaud Legrand, CNRS, University of Grenoble

LIG laboratory, arnaud.legrand@imag.fr

September 24, 2012

Outline

- 1 Killer applications
- 2 Why All Computers must be Parallel
 - Moore Law and Computing Limits
 - Multiple Cores Save Power
 - The Memory Limit
 - Conclusion
- 3 Concurrency Within a CPU
 - Pipelining
 - Instruction Level Parallelism
 - Vector Units
 - Hardware Support for Multi-Threading
- 4 Concurrency Within a Box
 - SMP
 - Multi-cores
 - Accelerators: GPU
- 5 Concurrency Across Boxes
 - Clusters
 - What next?

Parallel Architectures

A. Legrand

Killer applications

Computers must be Parallel

Moore

Power Saving

Memory Limit

Conclusion

Concurrency Within a CPU

Pipelining

ILP

Vector Units

Multi-Threading

Concurrency Within a Box

SMP

Multi-cores

Accelerators:

GPU

Concurrency Across Boxes

Clusters

What next?

Outline

Parallel Architectures

A. Legrand

Killer applications

Computers must be Parallel

Moore

Power Saving

Memory Limit

Conclusion

Concurrency Within a CPU

Pipelining

ILP

Vector Units

Multi-Threading

Concurrency Within a Box

SMP

Multi-cores

Accelerators:

GPU

Concurrency Across Boxes

Clusters

What next?

- 1 Killer applications
- 2 Why All Computers must be Parallel
 - Moore Law and Computing Limits
 - Multiple Cores Save Power
 - The Memory Limit
 - Conclusion
- 3 Concurrency Within a CPU
 - Pipelining
 - Instruction Level Parallelism
 - Vector Units
 - Hardware Support for Multi-Threading
- 4 Concurrency Within a Box
 - SMP
 - Multi-cores
 - Accelerators: GPU
- 5 Concurrency Across Boxes
 - Clusters
 - What next?

Killer applications

Computers must be Parallel

Moore

Power Saving

Memory Limit

Conclusion

Concurrency Within a CPU

Pipelining

ILP

Vector Units

Multi-Threading

Concurrency Within a Box

SMP

Multi-cores

Accelerators: GPU

Concurrency Across Boxes

Clusters

What next?

Intensive Computation Applications

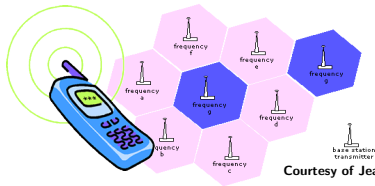
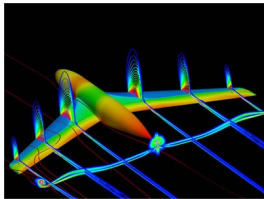

Courtesy of Jean-François Méhaut

Computing Power Drivers

“Grand Challenge” Applications using computing power and also memory

Models, simulations and analysis

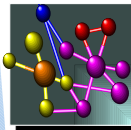

Life Sciences

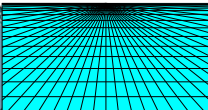

Aerospace



E-commerce



CAD/CAM



Digital Biology



Military Applications

Parallel Architectures

A. Legrand

Killer applications

Computers must be Parallel

Moore

Power Saving

Memory Limit

Conclusion

Concurrency

Within a CPU

Pipelining

ILP

Vector Units

Multi-Threading

Concurrency

Within a Box

SMP

Multi-cores

Accelerators:

GPU

Concurrency

Across Boxes

Clusters

What next?

The Large Hadron Collider Project 4 detectors

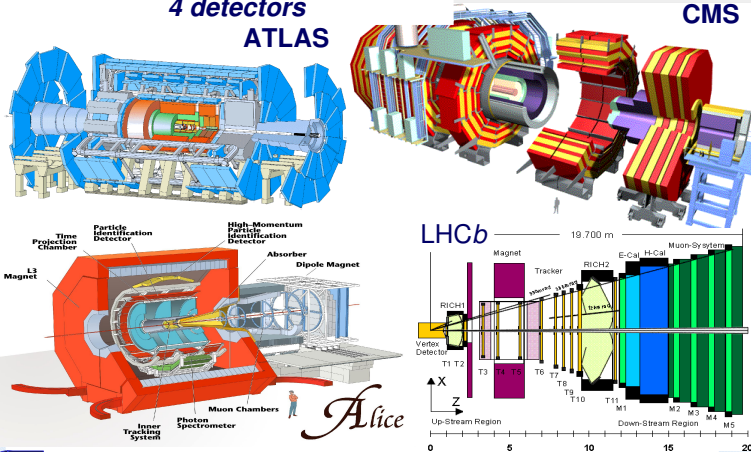

Courtesy of Jean-François Méhaut

The Large Hadron Collider Project 4 detectors

ATLAS

CMS

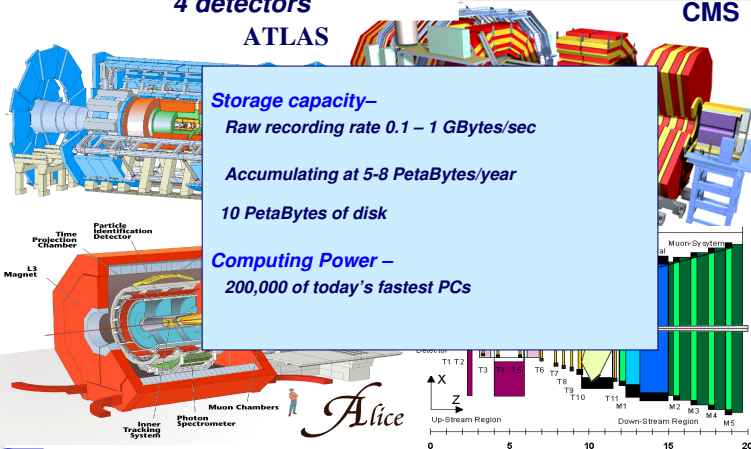

Earthquake Hazard Assessment

2001 Gujarati (M 7.7) Earthquake, India

Use parallel computing to simulate earthquakes

Learn about structure of the Earth based upon seismic waves (tomography)

Produce seismic hazard maps (local/regional scale)
e.g. Los Angeles, Tokyo, Mexico City, Seattle

Demo



20,000 people killed
167,000 injured
≈ 339,000 buildings destroyed
783,000 buildings damaged

Outline

Parallel Architectures

A. Legrand

Killer applications

Computers must be Parallel

Moore

Power Saving

Memory Limit

Conclusion

Concurrency Within a CPU

Pipelining

ILP

Vector Units

Multi-Threading

Concurrency Within a Box

SMP

Multi-cores

Accelerators:

GPU

Concurrency Across Boxes

Clusters

What next?

- 1 Killer applications
- 2 Why All Computers must be Parallel
 - Moore Law and Computing Limits
 - Multiple Cores Save Power
 - The Memory Limit
 - Conclusion
- 3 Concurrency Within a CPU
 - Pipelining
 - Instruction Level Parallelism
 - Vector Units
 - Hardware Support for Multi-Threading
- 4 Concurrency Within a Box
 - SMP
 - Multi-cores
 - Accelerators: GPU
- 5 Concurrency Across Boxes
 - Clusters
 - What next?

Technology Trends: Microprocessor Capacity

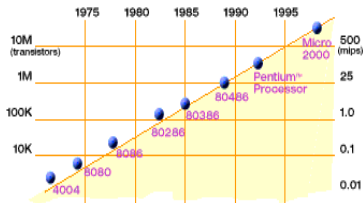

2X transistors/Chip Every 1.5 years
Called "Moore's Law"

Microprocessors have become smaller, denser, and more powerful.

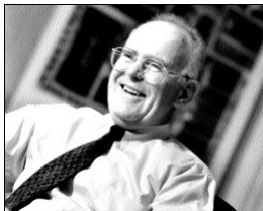

Gordon Moore (co-founder of Intel) predicted in 1965 that the transistor density of semiconductor chips would double roughly every 18 months.

Slide source: Jack Dongarra

Parallel Architectures

A. Legrand

Killer applications

Computers must be Parallel

Moore

Power Saving
Memory Limit
Conclusion

Concurrency Within a CPU

Pipelining
ILP
Vector Units
Multi-Threading

Concurrency Within a Box

SMP
Multi-cores
Accelerators:
GPU

Concurrency Across Boxes

Clusters
What next?

MOORE'S LAW

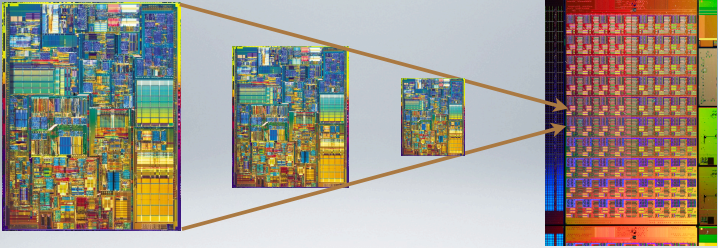

The diagram shows three microprocessors of increasing size and complexity, connected by arrows pointing from left to right. The first processor on the left is the smallest and least complex. The second processor in the middle is larger and more complex. The third processor on the right is the largest and most complex, with a dense grid of components. The arrows indicate a progression from left to right, representing the exponential growth of transistors over time as described by Moore's Law.

1971: INTEL 4004

With today's technology could
place 15 complete processors
on each transistor of the
original

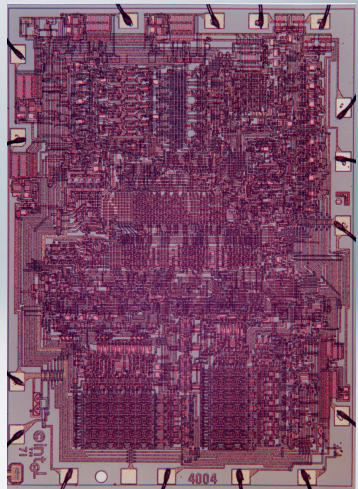

Parallel Architectures

A. Legrand

Killer applications

Computers must be Parallel

Moore

Power Saving
Memory Limit
Conclusion

Concurrency Within a CPU

Pipelining
ILP
Vector Units
Multi-Threading

Concurrency Within a Box

SMP
Multi-cores
Accelerators: GPU

Concurrency Across Boxes
Clusters
What next?

Silicon Future

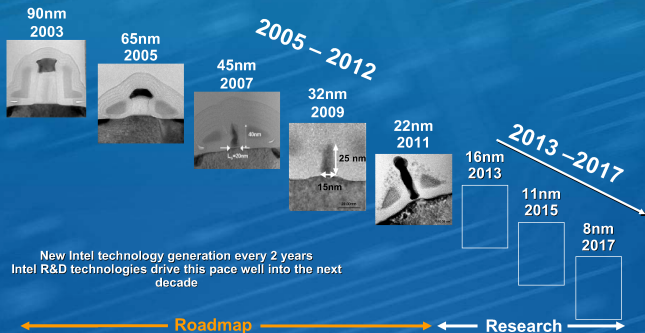

Limit #1: Power density

Can soon put more transistors on a chip than can afford to turn on.

-- Patterson '07

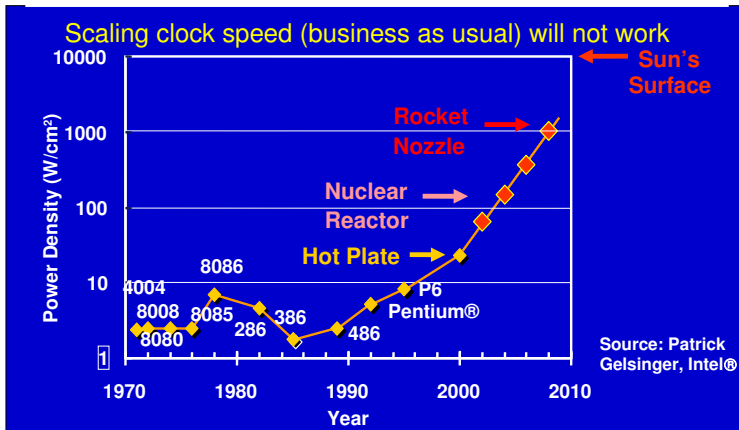

Parallel Architectures

A. Legrand

Killer applications

Computers must be Parallel

Moore

Power Saving
Memory Limit
Conclusion

Concurrency
Within a CPU

Pipelining
ILP
Vector Units
Multi-Threading

Concurrency
Within a Box

SMP
Multi-cores
Accelerators:
GPU

Concurrency
Across Boxes
Clusters
What next?

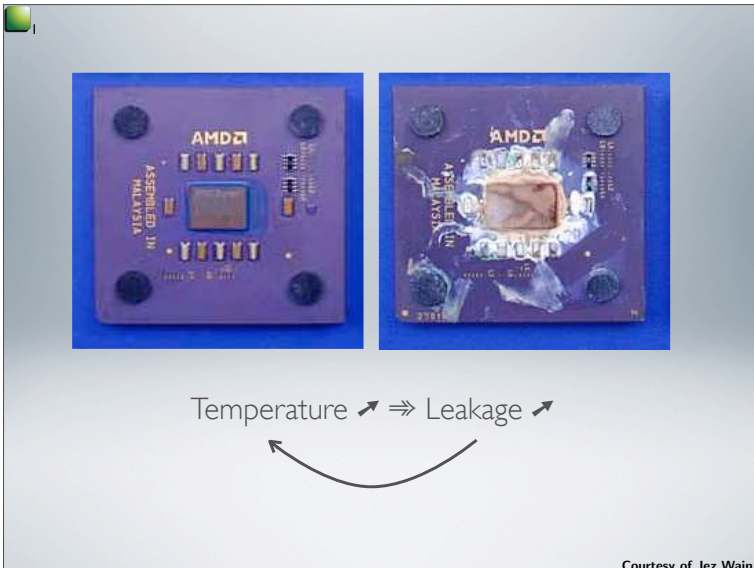

Moore's Law

- Many people interpret Moore's law as "computer gets twice as fast every 18/24 months"
 - which is not true
 - The law is about transistor density
- **This wrong interpretation is no longer true**
- We should have 20GHz processors right now
- And we don't!

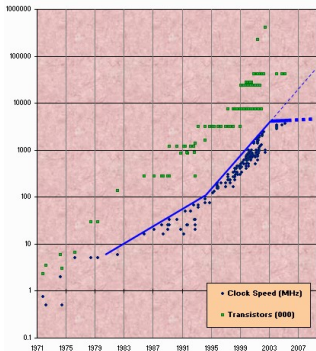

Limit #2: Hidden Parallelism Tapped Out

- **Superscalar (SS) designs were the state of the art; many forms of parallelism not visible to programmer**
 - **multiple instruction issue**
 - **dynamic scheduling: hardware discovers parallelism between instructions**
 - **speculative execution: look past predicted branches**
 - **non-blocking caches: multiple outstanding memory ops**
- **You may have heard of these in 61C, but you haven't needed to know about them to write software**

- **Unfortunately, these sources have been used up**

Limit #3: Speed of Light (Fundamental)

1 Tflop/s, 1
Tbyte sequential
machine



$r = 0.3$
mm

- Consider the 1 Tflop/s sequential machine:
 - Data must travel some distance, r , to get from memory to CPU.
 - To get 1 data element per cycle, this means 10^{12} times per second at the speed of light, $c = 3 \times 10^8$ m/s. Thus $r < c/10^{12} = 0.3$ mm.
- Now put 1 Tbyte of storage in a 0.3 mm x 0.3 mm area:
 - Each bit occupies about 1 square Angstrom, or the size of a small atom.
- No choice but parallelism



No more Moore?

- We are used to getting faster CPUs all the time
- We are used for them to keep up with more demanding software
- Known as “Andy giveth, and Bill taketh away”
 - Andy Grove
 - Bill Gates
- It’s a nice way to force people to buy computers often
- But basically, our computers get better, do more things, and it just happens automatically
- Some people call this the “performance free lunch”
- **Conventional wisdom:** “Not to worry, tomorrow’s processors will have even more throughput, and anyway today’s applications are increasingly throttled by factors other than CPU throughput and memory speed (e.g.,



Commodity improvements

- There are three main ways in which commodity processors keep improving:
 - Higher clock rate
 - More aggressive instruction reordering and concurrent units
 - Bigger/faster caches
- All applications can easily benefit from these improvements
 - at the cost of perhaps a recompilation
- Unfortunately, the first two are hitting their limit
 - Higher clock rate lead to high heat, power consumption
 - No more instruction reordering without compromising correctness



Is Moore's laws not true?

- Ironically, Moore's law is still true
 - The density indeed still doubles
- But its wrong interpretation is not
 - Clock rates do not doubled any more
- But we can't let this happen: computers **have** to get more powerful
- Therefore, the industry has thought of new ways to improve them: **multi-core**
 - Multiple CPUs on a single **chip**
- Multi-core adds another level of concurrency
 - But unlike, say multiple functional units, hard to compile for them
 - Therefore, programmers need to be trained to develop code for multi-core platforms
 - See ICS432

Parallelism Saves Power

- Exploit explicit parallelism for reducing power
 - Intel Slides
- **Using additional cores**
 - Increase density (= more transistors = more capacitance)
 - Can increase cores (2x) and performance (2x)
 - Or increase cores (2x), but decrease frequency (1/2): same performance at 1/4 the power
- **Additional benefits**
 - Small/simple cores → more predictable performance

Parallel Architectures

A. Legrand

Killer applications

Computers must be Parallel

Moore

Power Saving

Memory Limit

Conclusion

Concurrency

Within a CPU

Pipelining

ILP

Vector Units

Multi-Threading

Concurrency

Within a Box

SMP

Multi-cores

Accelerators:

GPU

Concurrency

Across Boxes

Clusters

What next?

Why Multi-Core?

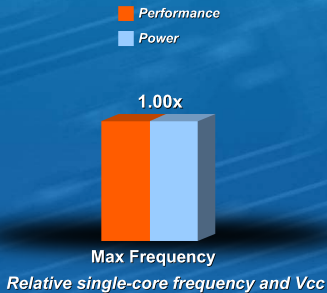

Parallel Architectures

A. Legrand

Killer applications

Computers must be Parallel

Moore

Power Saving

Memory Limit

Conclusion

Concurrency

Within a CPU

Pipelining

ILP

Vector Units

Multi-Threading

Concurrency

Within a Box

SMP

Multi-cores

Accelerators:

GPU

Concurrency

Across Boxes

Clusters

What next?

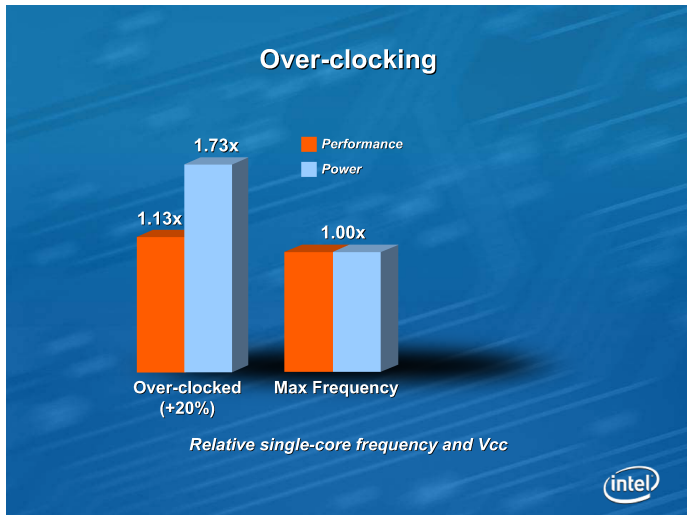

Parallel Architectures

A. Legrand

Killer applications

Computers must be Parallel

Moore

Power Saving

Memory Limit

Conclusion

Concurrency

Within a CPU

Pipelining

ILP

Vector Units

Multi-Threading

Concurrency

Within a Box

SMP

Multi-cores

Accelerators:

GPU

Concurrency

Across Boxes

Clusters

What next?

Under-clocking

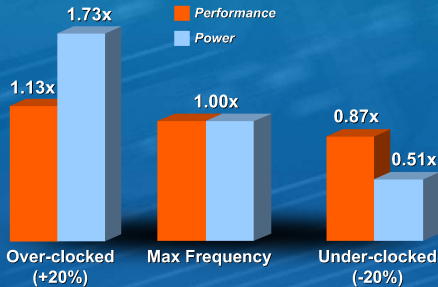

Relative single-core frequency and Vcc



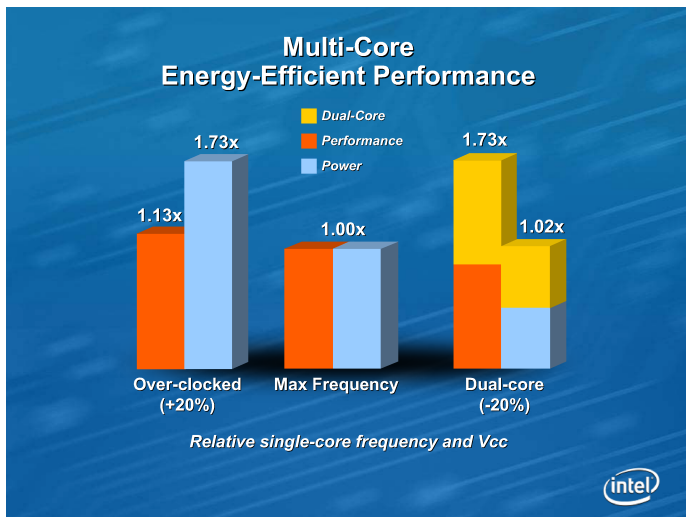

Parallelism Saves Power

- Exploit explicit parallelism for reducing power
 - Intel Slides
- **Using additional cores**
 - Increase density (= more transistors = more capacitance)
 - Can increase cores (2x) and performance (2x)
 - Or increase cores (2x), but decrease frequency (1/2): same performance at 1/4 the power
- **Additional benefits**
 - Small/simple cores → more predictable performance

Parallel Architectures

A. Legrand

Killer applications

Computers must be Parallel

Moore

Power Saving

Memory Limit

Conclusion

Concurrency

Within a CPU

Pipelining

ILP

Vector Units

Multi-Threading

Concurrency

Within a Box

SMP

Multi-cores

Accelerators:

GPU

Concurrency

Across Boxes

Clusters

What next?



EVOLUTION: TERAFL0P 1996

Courtesy of Jez Wain (BULL)

Parallel Architectures

A. Legrand

Killer applications

Computers must be Parallel

Moore

Power Saving

Memory Limit

Conclusion

Concurrency

Within a CPU

Pipelining

ILP

Vector Units

Multi-Threading

Concurrency

Within a Box

SMP

Multi-cores

Accelerators:

GPU

Concurrency

Across Boxes

Clusters

What next?



1,000 FLOPS PER WATT

Courtesy of Jez Wain (BULL)

Parallel Architectures

A. Legrand

Killer applications

Computers must be Parallel

Moore

Power Saving

Memory Limit

Conclusion

Concurrency

Within a CPU

Pipelining

ILP

Vector Units

Multi-Threading

Concurrency

Within a Box

SMP

Multi-cores

Accelerators:

GPU

Concurrency

Across Boxes

Clusters

What next?



EVOLUTION: 2.4 TERAFLUPS 2009

Courtesy of Jez Wain (BULL)

Parallel Architectures

A. Legrand

Killer applications

Computers must be Parallel

Moore

Power Saving

Memory Limit

Conclusion

Concurrency

Within a CPU

Pipelining

ILP

Vector Units

Multi-Threading

Concurrency

Within a Box

SMP

Multi-cores

Accelerators:

GPU

Concurrency

Across Boxes

Clusters

What next?



1,600,000 FLOPS PER WATT

DATA-CENTRES 2007

200B kWh
\$29B in power and cooling

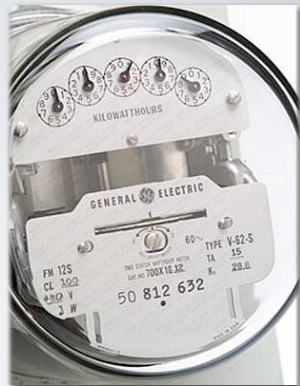

1% of world's electricity goes to cooling IT

Parallel Architectures

A. Legrand

Killer applications

Computers must be Parallel

Moore

Power Saving

Memory Limit

Conclusion

Concurrency

Within a CPU

Pipelining

ILP

Vector Units

Multi-Threading

Concurrency

Within a Box

SMP

Multi-cores

Accelerators:

GPU

Concurrency

Across Boxes

Clusters

What next?



IT: 2% OF WORLD CO₂

Parallel Architectures

A. Legrand

Killer applications

Computers must be Parallel

Moore

Power Saving

Memory Limit

Conclusion

Concurrency

Within a CPU

Pipelining

ILP

Vector Units

Multi-Threading

Concurrency

Within a Box

SMP

Multi-cores

Accelerators:

GPU

Concurrency

Across Boxes

Clusters

What next?

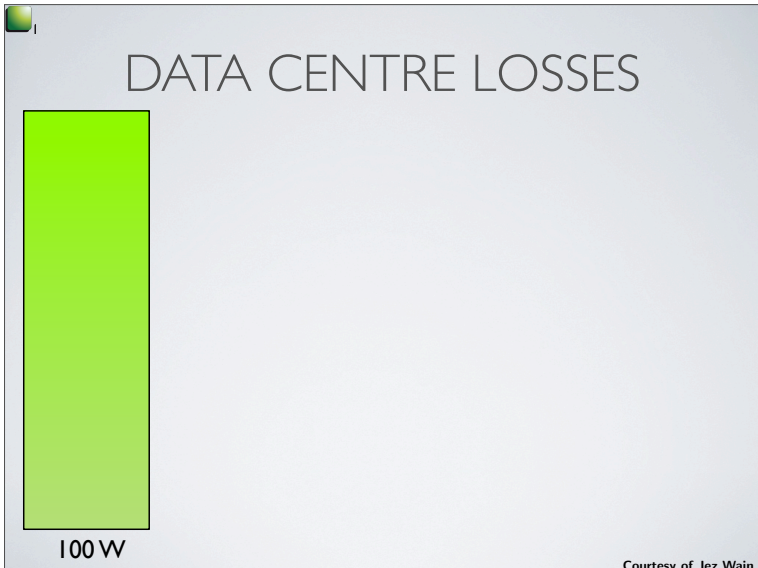

Parallel Architectures

A. Legrand

Killer applications

Computers must be Parallel

Moore

Power Saving

Memory Limit

Conclusion

Concurrency

Within a CPU

Pipelining

ILP

Vector Units

Multi-Threading

Concurrency

Within a Box

SMP

Multi-cores

Accelerators: GPU

GPU

Concurrency

Across Boxes

Clusters

What next?

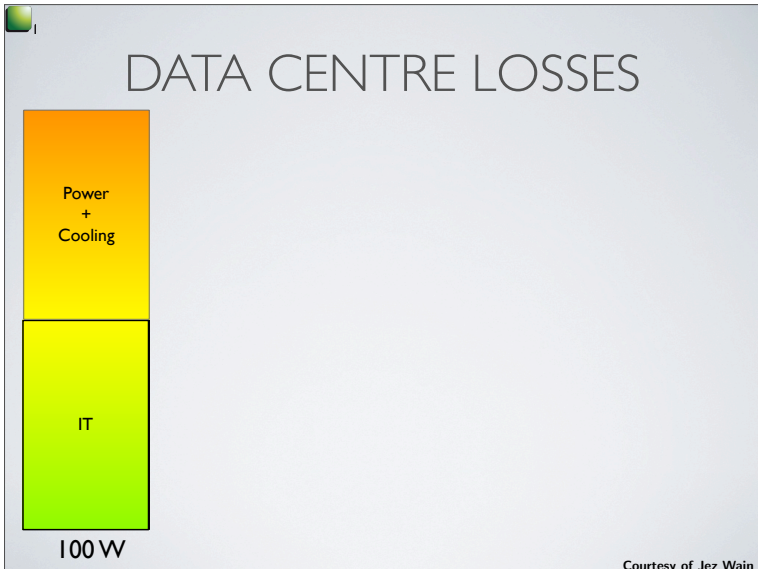

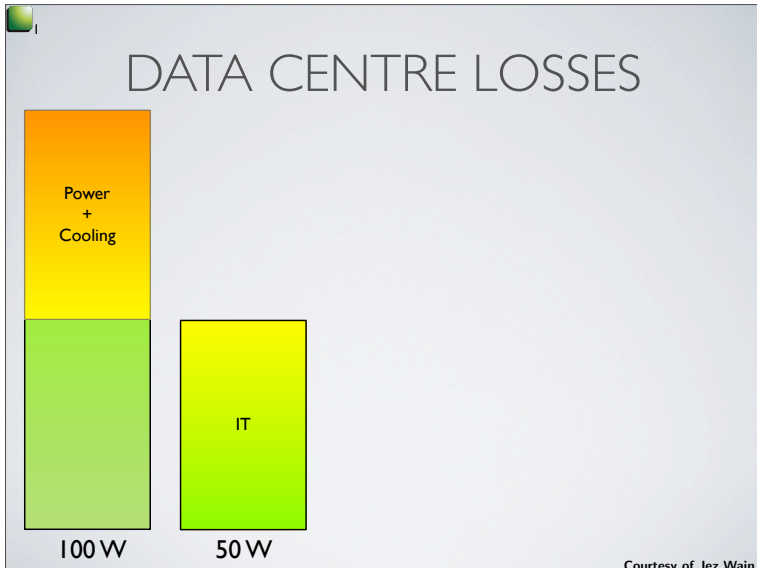

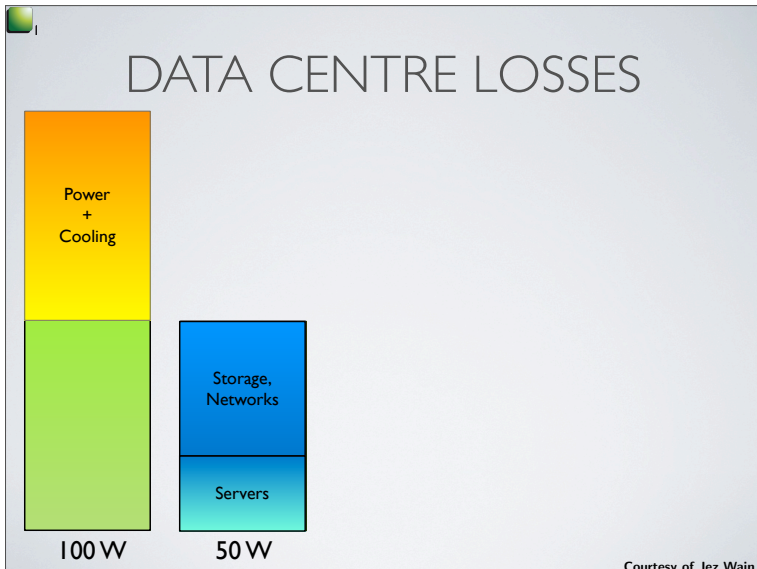

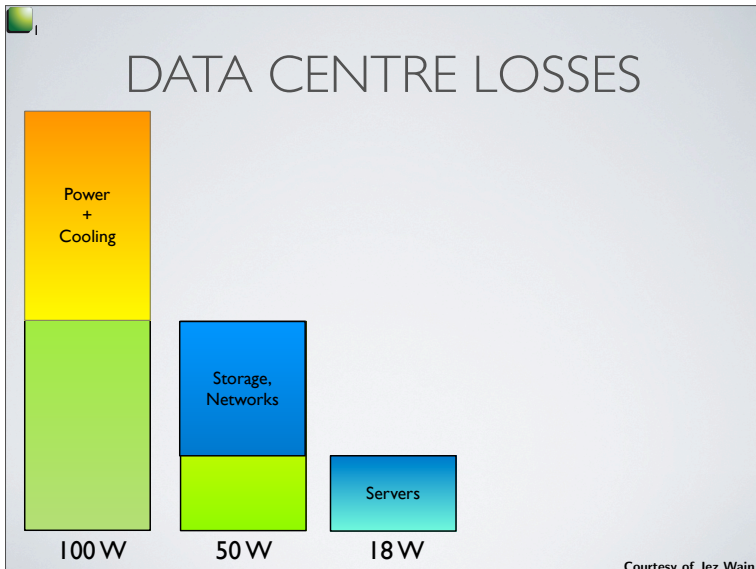

DATA CENTRE LOSSES

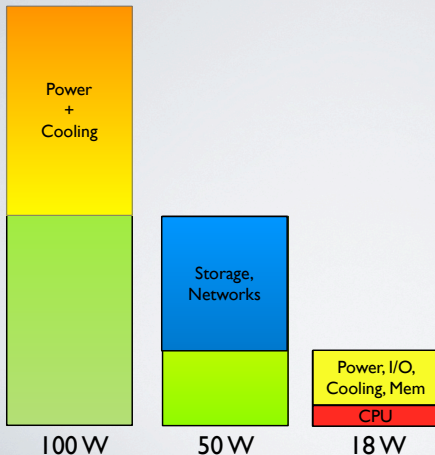

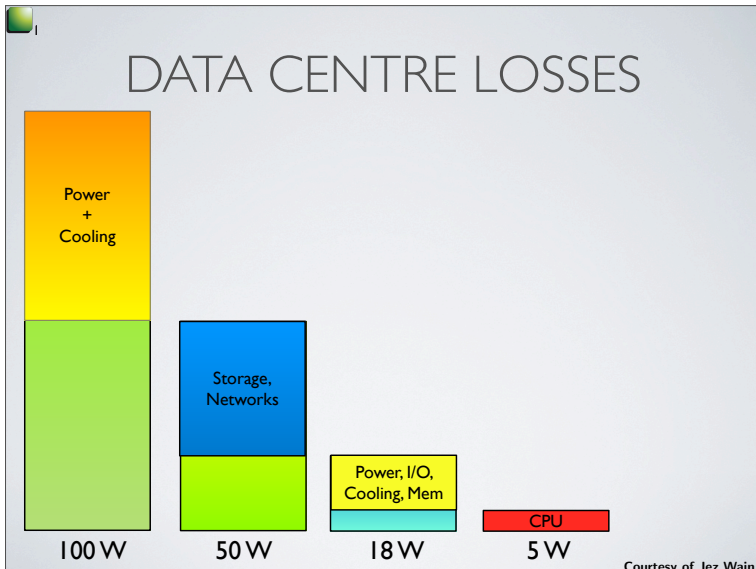

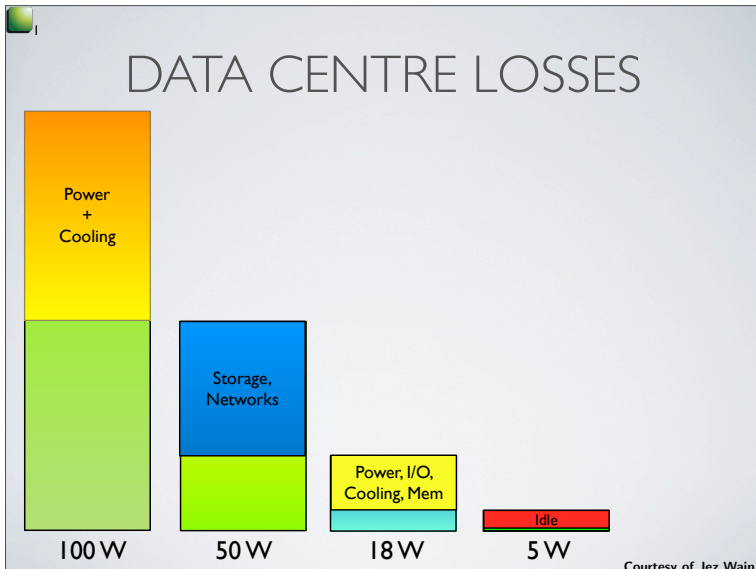

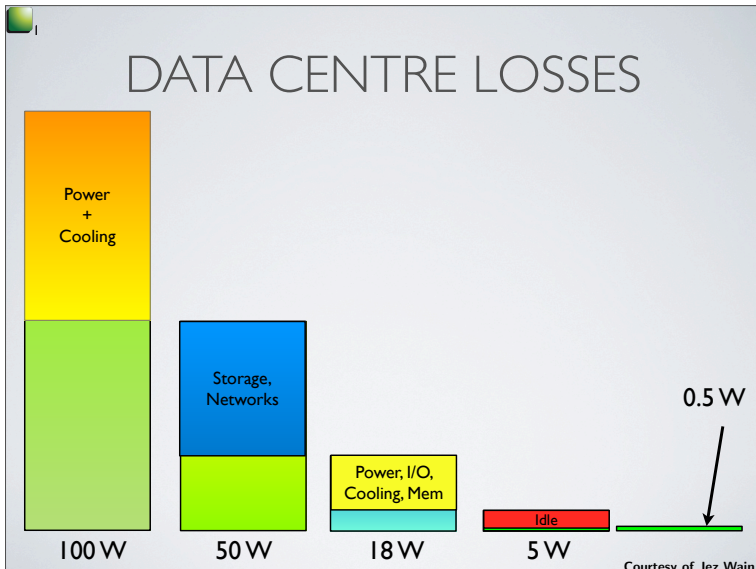

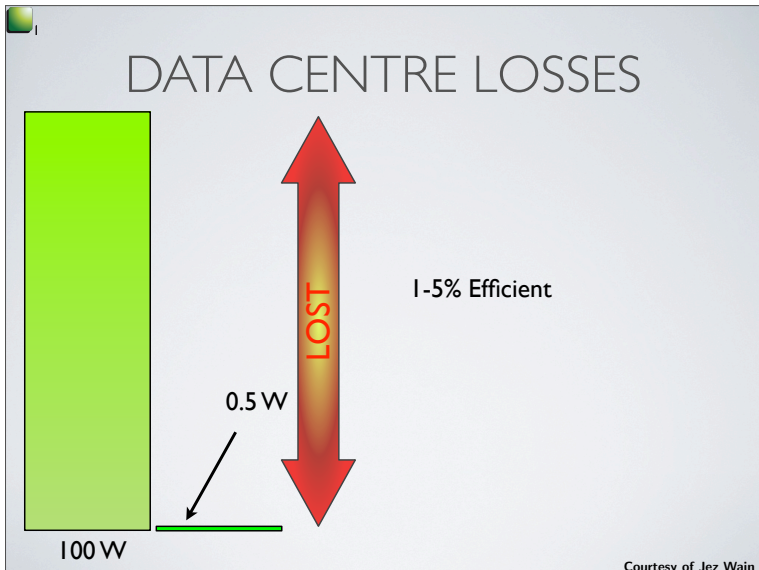

Parallel Architectures

A. Legrand

Killer applications

Computers must be Parallel

Moore

Power Saving

Memory Limit

Conclusion

Concurrency

Within a CPU

Pipelining

ILP

Vector Units

Multi-Threading

Concurrency

Within a Box

SMP

Multi-cores

Accelerators:

GPU

Concurrency

Across Boxes

Clusters

What next?



DATA CENTRE EFFICIENCY

I-5% Efficient

Courtesy of Jez Wain (BULL)

Parallel Architectures

A. Legrand

Killer applications

Computers must be Parallel

Moore

Power Saving

Memory Limit

Conclusion

Concurrency Within a CPU

Pipelining

ILP

Vector Units

Multi-Threading

Concurrency Within a Box

SMP

Multi-cores

Accelerators: GPU

Concurrency Across Boxes

Clusters

What next?



DATA CENTRE EFFICIENCY



1-5% Efficient

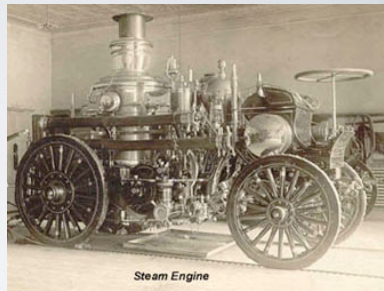

Steam Engine

10-15% Efficient



The Memory Bottleneck

- The memory is a very common bottleneck that beginning programmers often don't think about
 - When you look at code, you often pay more attention to computation
 - $a[i] = b[j] + c[k]$
 - The access to the 3 arrays take more time than doing an addition
 - For the code above, the memory is the bottleneck for many machines!

Why the Memory Bottleneck?

- In the 70's, everything was balanced
 - The memory kept pace with the CPU
 - n cycles to execute an instruction, n cycles to bring in a word from memory
- No longer true
 - CPUs have gotten 1,000x faster
 - Memory have gotten 10x faster and 1,000,000x larger
- ➔ Flops are free and bandwidth is expensive and processors are **STARVED** for data

Parallel Architectures

A. Legrand

Killer applications

Computers must be Parallel

Moore

Power Saving

Memory Limit

Conclusion

Concurrency

Within a CPU

Pipelining

ILP

Vector Units

Multi-Threading

Concurrency

Within a Box

SMP

Multi-cores

Accelerators:

GPU

Concurrency

Across Boxes

Clusters

What next?

Increasing I/O Signaling Rate to Fill the Gap

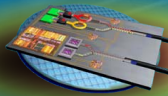
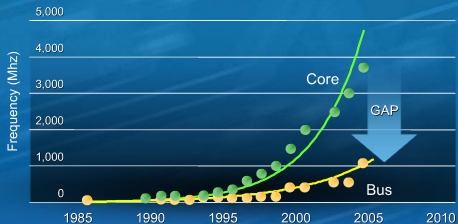

Silicon Photonics

Source: Intel





Current Memory Technology

Memory	Latency	Peak Bandwidth
DDR400 SDRAM	10 ns	6.4 GB/sec
DDR533 SDRAM	9.4 ns	8.5 GB/sec
DDR2-533 SDRAM	11.2 ns	8.5 GB/sec
DDR2-600 SDRAM	13.3 ns	9.6 GB/sec
DDR2-667 SDRAM	???	10.6 GB/sec
DDR2-800 SDRAM	???	12.8 GB/sec

source: http://www.xbitlabs.com/articles/memory/display/ddr2-ddr_2.html



Memory Bottleneck: Example

- Fragment of code: $a[i] = b[j] + c[k]$
 - Three memory references: 2 reads, 1 write
 - One addition: can be done in one cycle
- If the memory bandwidth is 12.8GB/sec, then the rate at which the processor can access integers (4 bytes) is: $12.8 \times 1024 \times 1024 \times 1024 / 4 = 3.4\text{GHz}$
- The above code needs to access 3 integers
- Therefore, the rate at which the code gets its data is $\sim 1.1\text{GHz}$
- But the CPU could perform additions at 4GHz!
- Therefore: **The memory is the bottleneck**
 - And we assumed memory worked at the peak!!!
 - We ignored other possible overheads on the bus
 - In practice the gap can be around a factor 15 or higher

Reducing the Memory Bottleneck

- The way in which computer architects have dealt with the memory bottleneck is via the memory **hierarchy**

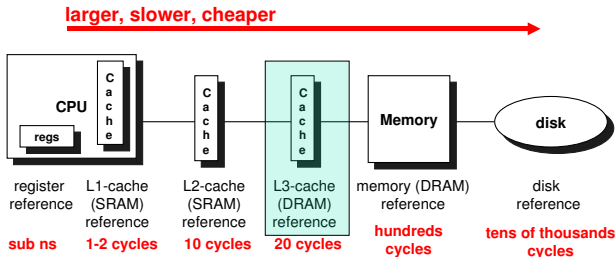



Locality

- The memory hierarchy is useful because of “locality”
- **Temporal locality**: a memory location that was referenced in the past is likely to be referenced again
- **Spatial locality**: a memory location next to one that was referenced in the past is likely to be referenced in the near future
- This is great, but what we write our code for performance we want our code to have the **maximum** amount of locality
 - The compiler can do some work for us regarding locality
 - But unfortunately not everything



Programming for Locality

- Essentially, a programmer should keep a mental picture of the memory layout of the application, and reason about locality
 - When writing concurrent code on a multi-core architecture, one must also think of which caches are shared/private
- This can be extremely complex, but there are a few well-known techniques
- The typical example is with 2-D arrays

Parallel Architectures

A. Legrand

Killer applications

Computers must be Parallel

Moore

Power Saving

Memory Limit

Conclusion

Concurrency

Within a CPU

Pipelining

ILP

Vector Units

Multi-Threading

Concurrency

Within a Box

SMP

Multi-cores

Accelerators:

GPU

Concurrency

Across Boxes

Clusters

What next?

Increasing Memory Bandwidth *to Keep Pace*

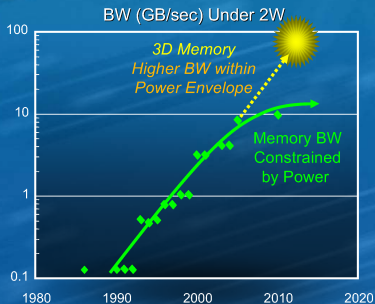

3D Memory Stacking

Power and IO Signals Go
Through DRAM to CPU

Thin DRAM Die

Through DRAM Vias

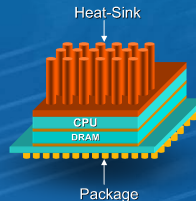

Source: Intel



Parallel Architectures

A. Legrand

Killer applications

Computers must be Parallel

Moore

Power Saving

Memory Limit

Conclusion

Concurrency

Within a CPU

Pipelining

ILP

Vector Units

Multi-Threading

Concurrency

Within a Box

SMP

Multi-cores

Accelerators:

GPU

Concurrency

Across Boxes

Clusters

What next?

What can we expect!

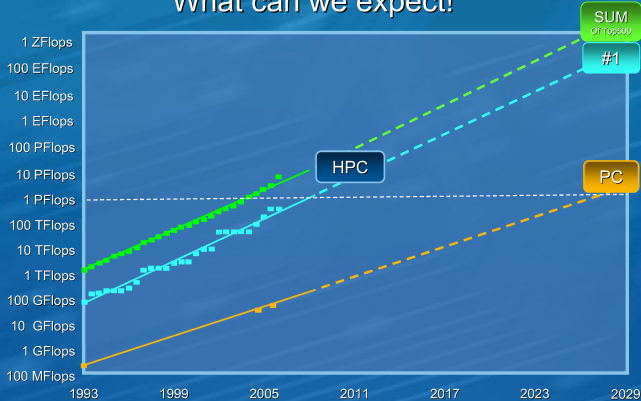

Source: HPC - www.top500.org, June 2006, Intel



Revolution is Happening Now

- Chip density is continuing increase
~2x every 2 years
 - Clock speed is not
 - Number of processor cores may double instead
- There is little or no hidden parallelism (ILP) to be found
- Parallelism must be exposed to and managed by software

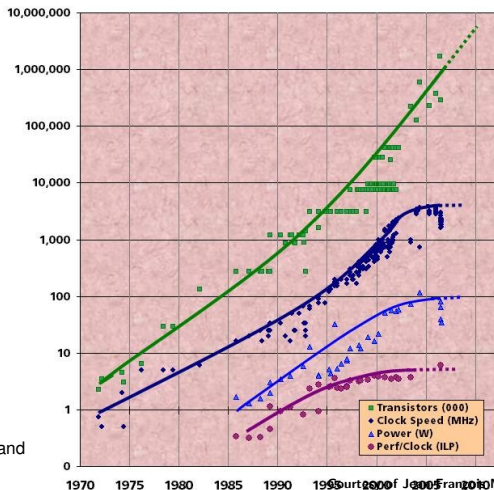

Source: Intel, Microsoft (Sutter) and Stanford (Olukotun, Hammond)

Multicore in Products

- “We are dedicating all of our future product development to multicore designs. ... This is a sea change in computing”

Paul Otellini, President, Intel (2005)

- All microprocessor companies switch to MP (2X CPUs / 2 yrs)
⇒ Procrastination penalized: 2X sequential perf. / 5 yrs

Manufacturer/Year	AMD/'05	Intel/'06	IBM/'04	Sun/'07
Processors/chip	2	2	2	8
Threads/Processor	1	2	2	16
Threads/chip	2	4	4	128

And at the same time,

- The STI Cell processor (PS3) has 8 cores
- The latest NVidia Graphics Processing Unit (GPU) has 128 cores
- Intel has demonstrated the TeraScale processor (80-core), research chip

Moore's Law still holds but we are limited by the law of physics.

- ▶ With a single CPU, the speed of light will keep us away from TeraFlops.
- ▶ Increasing clock rate is bad (higher energy consumption, higher temperature \rightsquigarrow need for cooling and thus even higher energy consumption).
- ▶ Automatic concurrency inside CPU is already there without you even noticing it. Don't expect too much on this side.

To improve performances:

- ▶ We need many different computation units.
 - ▶ Yet, INTEL doesn't see the power-of-2 doubling of number of cores every 2 years or so (will work on improving socket architecture, cache, registers, instructions, ...)
 - ▶ the biggest challenge is keeping the reasonable balance we have today between memory bandwidth and flops
- ▶ Data need to be close to computation units and well managed.
- ▶ We need to expose parallelism and program with such architectures in mind.
- ▶ We need to keep the architecture in mind when designing algo-

Outline

Parallel Architectures

A. Legrand

Killer applications

Computers must be Parallel

Moore

Power Saving

Memory Limit

Conclusion

Concurrency Within a CPU

Pipelining

ILP

Vector Units

Multi-Threading

Concurrency Within a Box

SMP

Multi-cores

Accelerators:

GPU

Concurrency Across Boxes

Clusters

What next?

- 1 Killer applications
- 2 Why All Computers must be Parallel
 - Moore Law and Computing Limits
 - Multiple Cores Save Power
 - The Memory Limit
 - Conclusion
- 3 Concurrency Within a CPU
 - Pipelining
 - Instruction Level Parallelism
 - Vector Units
 - Hardware Support for Multi-Threading
- 4 Concurrency Within a Box
 - SMP
 - Multi-cores
 - Accelerators: GPU
- 5 Concurrency Across Boxes
 - Clusters
 - What next?

*

Concurrency within a CPU

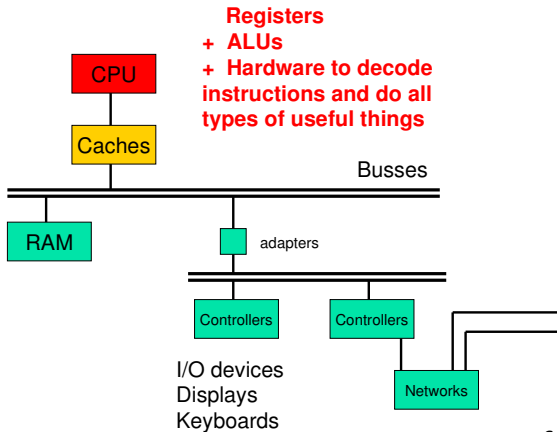



Concurrency within a CPU

- Several techniques to allow concurrency within a single CPU
 - Pipelining
 - RISC architectures
 - Pipelined functional units
 - ILP
 - Vector units
 - Hardware support of multi-threading
- Let's look at them briefly



Concurrency within a CPU

- Several techniques to allow concurrency within a single CPU
 - **Pipelining**
 - RISC architectures
 - Pipelined functional units
 - ILP
 - Vector units
 - Hardware support of multi-threading
- Let's look at them briefly



Pipelining

- If one has a sequence of tasks to do
- If each task consists of the same n steps or *stages*
- If different steps can be done simultaneously
- Then one can have a pipelined execution of the tasks
 - e.g., for assembly line
- Goal: higher throughput (i.e., number of tasks per time unit)

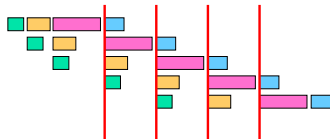

Time to do 1 task	= 9
Time to do 2 tasks	= 13
Time to do 3 tasks	= 17
Time to do 4 tasks	= 21
Time to do 10 tasks	= 45
Time to do 100 tasks	= 409

Pays off if many tasks

Pipelining

- Each step goes as fast as the slowest stage
- Therefore, the asymptotic throughput (i.e., the throughput when the number of tasks tends to infinity) is equal to:
$$1 / (\text{duration of the slowest stage})$$

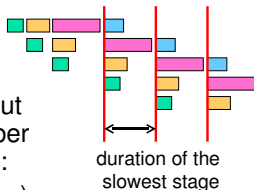

- Therefore, in an ideal pipeline, all stages would be identical (balanced pipeline)
- Question:** Can we make computer instructions all consist of the same number of stage, where all stages take the same number of clock cycles?



RISC

- Having all instructions doable in the same number of stages of the same durations is the RISC idea
- Example:
 - MIPS architecture (See THE architecture book by Patterson and Hennessy)
 - 5 stages
 - Instruction Fetch (IF)
 - Instruction Decode (ID)
 - Instruction Execute (EX)
 - Memory accesses (MEM)
 - Register Write Back (WB)
 - Each stage takes one clock cycle

**Concurrent execution
of two instructions**

LD R2, 12(R3)

DADD R3, R5, R6

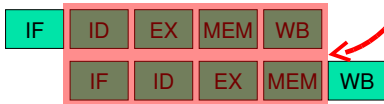

Pipelined Functional Units

- Although the RISC idea is attractive, some operations are just too expensive to be done in one clock cycle (during the EX stage)
- Common example: floating point operations
- Solution: implement them as a sequence of stages, so that they can be pipelined

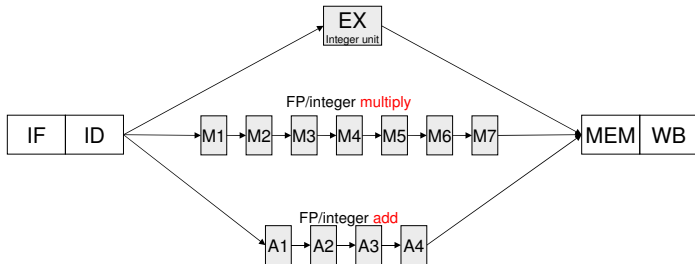



Pipelining Today

- Pipelined functional units are common
- Fallacy: All computers today are RISC
 - RISC was of course one of the most fundamental “new” ideas in computer architectures
 - x86: Most commonly used Instruction Set Architecture today
 - Kept around for backwards compatibility reasons, because it’s easy to implement (not to program for)
 - BUT: modern x86 processors decode instructions into “micro-ops”, which are then executed in a RISC manner
 - New Itanium architecture uses pipelining
- Bottom line: pipelining is a pervasive (and conveniently hidden) form of concurrency in computers today
 - Take a computer architecture course to know all about it



Concurrency within a CPU

- Several techniques to allow concurrency within a single CPU
 - Pipelining
 - ILP
 - Vector units
 - Hardware support of multi-threading



Instruction Level Parallelism

- Instruction Level Parallelism is the set of techniques by which performance of a pipelined processor can be pushed even further
- ILP can be done by the hardware
 - Dynamic instruction scheduling
 - Dynamic branch predictions
 - Multi-issue superscalar processors
- ILP can be done by the compiler
 - Static instruction scheduling
 - Multi-issue VLIW processors
 - with multiple functional units
- Broad concept: More than one instruction is issued per clock cycle
 - e.g., 8-way multi-issue processor



Concurrency within a CPU

- Several techniques to allow concurrency within a single CPU
 - Pipelining
 - ILP
 - **Vector units**
 - Hardware support of multi-threading

Vector Units

- A functional unit that can do elt-wise operations on entire vectors with a single instruction, called a vector instruction
 - These are specified as operations on **vector registers**
 - A “vector processor” comes with some number of such registers
 - MMX extension on x86 architectures

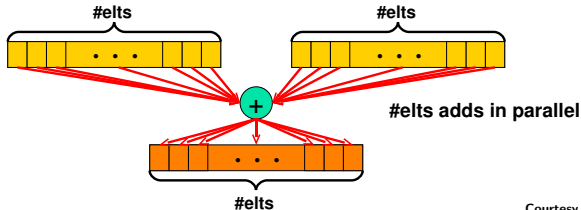

Vector Units

- Typically, a vector register holds ~ 32-64 elements
- But the number of elements is always larger than the amount of parallel hardware, called vector **pipes** or **lanes**, say 2-4

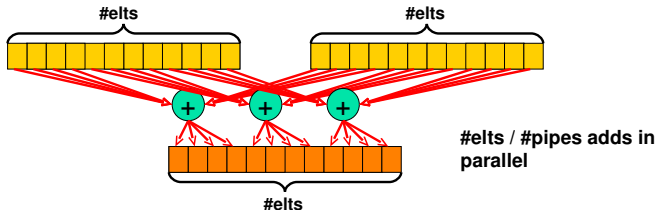



MMX Extension

- Many techniques that are initially implemented in the “supercomputer” market, find their way to the mainstream
- Vector units were pioneered in supercomputers
 - Supercomputers are mostly used for scientific computing
 - Scientific computing uses tons of arrays (to represent mathematical vectors and often does regular computation with these arrays)
 - Therefore, scientific code is easy to “vectorize”, i.e., to generate assembly that uses the vector registers and the vector instructions
- Intel’s MMX or PowerPC’s AltiVec
 - MMX vector registers
 - eight 8-bit elements
 - four 16-bit elements
 - two 32-bit elements
 - AltiVec: twice the lengths
- Used for “multi-media” applications
 - image processing
 - rendering
 - ...



Vectorization Example

- Conversion from RGB to YUV

$$Y = (9798 * R + 19235 * G + 3736 * B) / 32768;$$

$$U = (-4784 * R - 9437 * G + 4221 * B) / 32768 + 128;$$

$$V = (20218 * R - 16941 * G - 3277 * B) / 32768 + 128;$$

- This kind of code is perfectly parallel as all pixels can be computed independently
- Can be done easily with MMX vector capabilities
 - Load 8 R values into an MMX vector register
 - Load 8 G values into an MMX vector register
 - Load 8 B values into an MMX vector register
 - Do the *, +, and / in parallel
 - Repeat



Concurrency within a CPU

- Several techniques to allow concurrency within a single CPU
 - Pipelining
 - ILP
 - Vector units
 - Hardware support of multi-threading



Multi-threaded Architectures

- Computer architecture is a difficult field to make innovations in
 - Who's going to spend money to manufacture your new idea?
 - Who's going to be convinced that a new compiler can/should be written
 - Who's going to be convinced of a new approach to computing?
- One of the “cool” innovations in the last decade has been the concept of a “Multi-threaded Architecture”



Multi-threading

- Multi-threading has been arounds for years, so what's new about this???
- Here we're talking about **Hardware Support** for threads
 - Simultaneous Multi Threading (SMT)
 - SuperThreading
 - HyperThreading
- Let's try to understand what all of these mean before looking at multi-threaded Supercomputers



Single-threaded Processor

- The processor provides the illusion of concurrent execution
 - Front-end: fetching/decoding/reordering
 - Execution core: actual execution
- Multiple programs in memory
- Only one executes at a time
 - 4-issue CPU with bubbles
 - 7-unit CPU with pipeline bubbles
- Time-slicing via context switching

Simplified Example CPU

Front-end

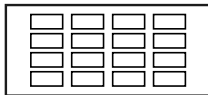

Execution Core

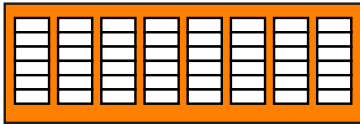

- The front-end can issue four instructions to the execution core simultaneously
 - 4-stage pipeline
- The execution core has 8 functional units
 - each a 6-stage pipeline

Simplified Example CPU

Front-end

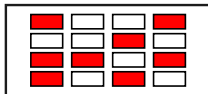

Execution Core

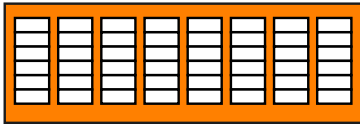

- The front-end is about to issue 2 instructions
- The cycle after it will issue 3
- The cycle after it will issue only 1
- The cycle after it will issue 2
- There is complex hardware that decides what can be issued

Simplified Example CPU

Front-end

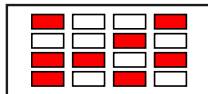

Execution Core

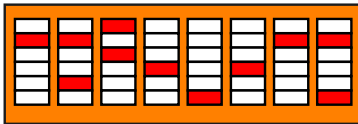

- At the current cycle, two functional units are used
- Next cycle one will be used
- And so on
- The while slots are “pipeline bubbles”: lost opportunity for doing useful work
 - Due to **low instruction-level parallelism** in the program

Multiple Threads in Memory

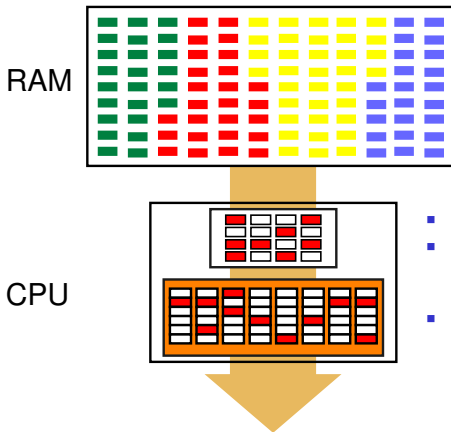

- Four threads in memory
- In a “traditional” architecture, only the “red” thread is executing
- When the O/S context switches it out, then another thread gets to run

Single-threaded SMP?

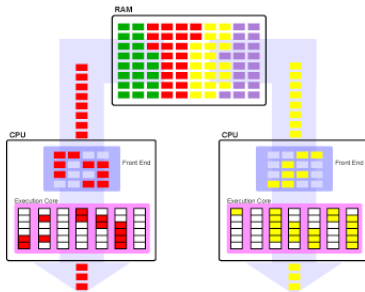

- Two threads execute at once, so threads spend less time waiting
- The number of “bubbles” is also doubled
- ➔ Twice as much speed and **twice as much waste**

Super-threading

- Principle: the processor can execute more than one thread at a time
- Also called time-slice multithreading
- The processor is then called a *multithreaded processor*
- Requires more hardware cleverness
 - logic switches at each cycle
- Leads to less Waste
 - A thread can run during a cycle while another thread is waiting for the memory
 - Just a finer grain of interleaving
- But there is a restriction
 - Each stage of the front end or the execution core only runs instructions from ONE thread!
- Does not help with poor instruction parallelism within one thread
 - Does not reduce bubbles within a row

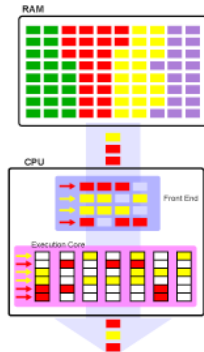

Hyper-threading

- Principle: the processor can execute more than one thread at a time, even within a single clock cycle!!
- Requires even more hardware cleverness
 - logic switches within each cycle
- On the diagram: Only two threads execute simultaneously.
 - Inter's hyper-threading only adds 5% to the die area
 - Some people argue that “two” is not “hyper” 😊
- Finest level of interleaving
- From the OS perspective, there are two “logical” processors

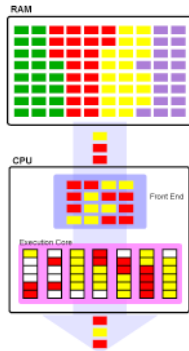

Parallel Architectures

A. Legrand

Killer applications

Computers must be Parallel

Moore

Power Saving

Memory Limit

Conclusion

Concurrency Within a CPU

Pipelining

ILP

Vector Units

Multi-Threading

Concurrency Within a Box

SMP

Multi-cores

Accelerators: GPU

Concurrency Across Boxes

Clusters

What next?

Multi-threaded Cores

All Large Core



Mixed Large and Small Core



All Small Core



Goal: Energy Efficient Petascale with Multi-threaded Cores

Note: the above pictures don't represent any current or future Intel products



Parallel Architectures

A. Legrand

Killer applications

Computers must be Parallel

Moore

Power Saving

Memory Limit

Conclusion

Concurrency

Within a CPU

Pipelining

ILP

Vector Units

Multi-Threading

Concurrency

Within a Box

SMP

Multi-cores

Accelerators:

GPU

Concurrency

Across Boxes

Clusters

What next?

Increasing Processor Performance

Through Multi-threaded Cores

Flops

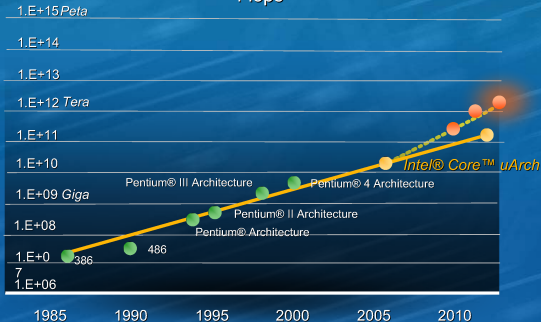

Reaching Petascale with ~5,000 Processors



Outline

Parallel Architectures

A. Legrand

Killer applications

Computers must be Parallel

Moore

Power Saving

Memory Limit

Conclusion

Concurrency Within a CPU

Pipelining

ILP

Vector Units

Multi-Threading

Concurrency Within a Box

SMP

Multi-cores

Accelerators:

GPU

Concurrency Across Boxes

Clusters

What next?

- 1 Killer applications
- 2 Why All Computers must be Parallel
 - Moore Law and Computing Limits
 - Multiple Cores Save Power
 - The Memory Limit
 - Conclusion
- 3 Concurrency Within a CPU
 - Pipelining
 - Instruction Level Parallelism
 - Vector Units
 - Hardware Support for Multi-Threading
- 4 Concurrency Within a Box
 - SMP
 - Multi-cores
 - Accelerators: GPU
- 5 Concurrency Across Boxes
 - Clusters
 - What next?



Concurrency within a “Box”

- Two main techniques
 - SMP
 - Multi-core
- Let's look at both of them



Multiple CPUs

- We have seen that there are many ways in which a single-threaded program can in fact achieve some amount of true concurrency in a modern processor
 - ILP, vector instructions
- On a hyper-threaded processors, a single-threaded program can also achieve some amount of true concurrency
- But there are limits to these techniques, and many systems provide increased true concurrency by using multiple CPUs

SMPs

- **Symmetric Multi-Processors**
 - often mislabeled as “Shared-Memory Processors”, which has now become tolerated
- Processors are all connected to a single memory
- Symmetric: each memory cell is equally close to all processors
- Many dual-proc and quad-proc systems
 - e.g., for servers

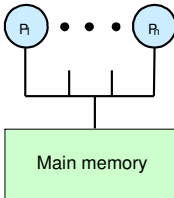

Shared Memory and Caches?

- When building a shared memory system with multiple processors / cores, one key question is: **where does one put the cache?**
- Two options

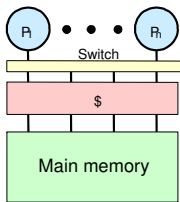

Shared Cache

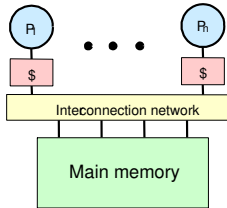

Private Caches



Shared Caches

Advantages

- Cache placement identical to single cache
 - Only one copy of any cached block
 - Can't have different values for the same memory location
- Good interference
 - One processor may prefetch data for another
 - Two processors can each access data within the same cache block, enabling fine-grain sharing

Disadvantages

- Bandwidth limitation
 - Difficult to scale to a large number of processors
 - Keeping all processors working in cache requires a lot of bandwidth
- Size limitation
 - Building a fast large cache is expensive
- Bad interference
 - One processor may flush another processor's data



Shared Caches

- Shared caches have known a strange evolution
- Early 1980s
 - Alliant FX-8
 - 8 processors with crossbar to interleaved 512KB cache
 - Encore & Sequent
 - first 32-bit microprocessors
 - two procs per board with a shared cache
- Then disappeared
- Only to reappear in recent MPPs
 - Cray X1: shared L3 cache
 - IBM Power 4 and Power 5: shared L2 cache
- Typical multi-proc systems do not use shared caches
- But they are common in multi-core systems

Caches and multi-core

- Typical multi-core architectures use distributed L1 caches

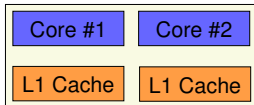

- But lower levels of caches are shared

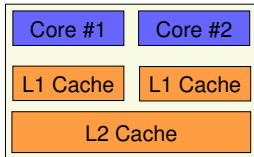

Multi-proc & multi-core systems

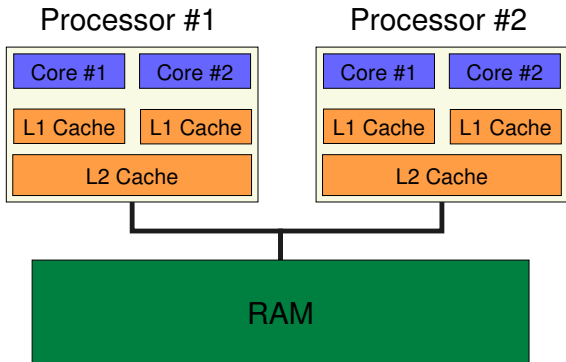



Private caches

- The main problem with private caches is that of **memory consistency**
- Memory consistency is jeopardized by having multiple caches
 - P1 and P2 both have a cached copy of a data item
 - P1 write to it, possibly write-through to memory
 - At this point P2 owns a stale copy
- When designing a multi-processor system, one must ensure that this cannot happen
 - By defining protocols for cache coherence

Snoopy Cache-Coherence



- The memory bus is a broadcast medium
- Caches contain information on which addresses they store
- Cache Controller “snoops” all transactions on the bus
 - A transaction is a relevant transaction if it involves a cache block currently contained in this cache
 - Take action to ensure coherence
 - invalidate, update, or supply value

Limits of Snoopy Coherence

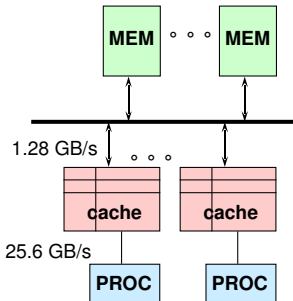

Assume:

4 GHz processor

=> 16 GB/s inst BW per processor (32-bit)

=> 9.6 GB/s data BW at 30% load-store of 8-byte elements

Suppose 98% inst hit rate and 90% data hit rate

=> 320 MB/s inst BW per processor

=> 960 MB/s data BW per processor

=> 1.28 GB/s combined BW

Assuming 10 GB/s bus bandwidth

8 processors will saturate the bus

Sample Machines

- Intel Pentium Pro Quad

- Coherent
- 4 processors

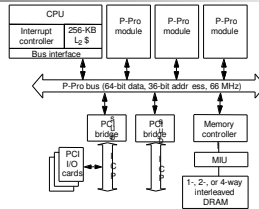

- Sun Enterprise server

- Coherent
- Up to 16 processor and/or memory-I/O cards

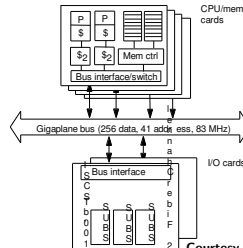

Courtesy of Henri Casanova



Directory-based Coherence

- Idea: Implement a “directory” that keeps track of where each copy of a data item is stored
- The directory acts as a filter
 - processors must ask permission for loading data from memory to cache
 - when an entry is changed the directory either update or invalidate cached copies
- Eliminate the overhead of broadcasting/snooping, a thus bandwidth consumption
- But is slower in terms of latency
- Used to scale up to numbers of processors that would saturate the memory bus

Example machine

- SGI Altix 3000
- A node contains up to 4 Itanium 2 processors and 32GB of memory
- Uses a mixture of snoopy and directory-based coherence
- Up to 512 processors that are cache coherent (global address space is possible for larger machines)



"Best of Show"
-LinuxWorld 2003



Sequential Consistency?

- A lot of hardware and technology to ensure cache coherence
- But the sequential consistency model may be broken anyway
 - The compiler reorders/removes code
 - Prefetch instructions cause reordering
 - The network may reorder two write messages
- Basically, a bunch of things can happen
- Virtually all commercial systems give up on the idea of maintaining strong sequential consistency



Weaker models

- The programmer must program with weaker memory models than Sequential Consistency
- Done with some rules
 - Avoid race conditions
 - Use system-provided synchronization primitives
- We will see how to program shared-memory machines
 - ICS432 is “all” about this
 - We’ll just do a brief “review” in 632

GPGPU

- General Purpose computation on the GPU (Graphics Processing Unit)
 - Started in computer graphics community
 - Mapping computation problems to graphics rendering pipeline

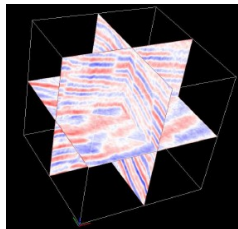
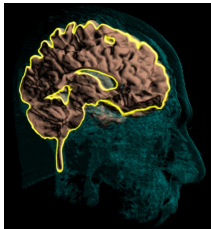
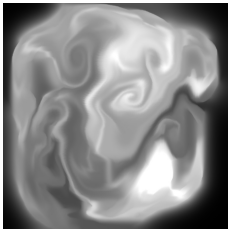

Courtesy Jens Krueger and Aaron Lefohn

GPU is for Parallel Computing

- CPU
 - Large cache and sophisticated flow control minimize latency for arbitrary memory access for serial process
- GPU
 - Simple flow control and limited cache, more transistors for computing in parallel
 - High arithmetic intensity hides memory latency

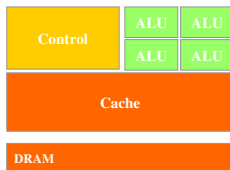

CPU

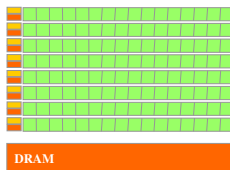

GPU

Courtesy NVIDIA

Courtesy of Jean-François Méhaut

Why GPU for Computing?

- GPU is fast
 - Massively parallel
 - CPU : ~4 @ 3.0 Ghz (Intel Quad Core)
 - GPU : ~128 @ 1.35 Ghz (Nvidia GeForce 8800 GTX)
 - High memory bandwidth
 - CPU : 21 GB/s
 - GPU : 86 GB/s
 - Simple architecture optimized for compute intensive task
- Programmable
 - Shaders, NVIDIA CUDA, ATI CTM
- High precision floating point support
 - 32bit floating point IEEE 754
 - 64bit floating point will be available in early 2008

Why GPU for computing?

- Inexpensive supercomputer
 - Two NVIDIA Tesla D870 : 1 TFLOPS
- GPU hardware performance increases faster than CPU
 - Trend : simple, scalable architecture, interaction of clock speed, cache, memory (bandwidth)

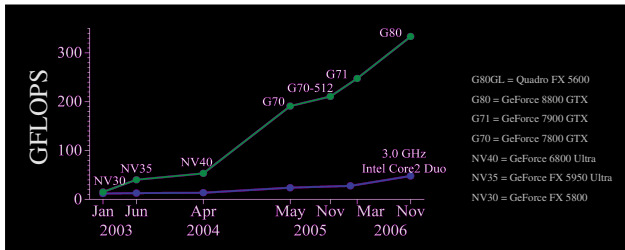

Courtesy NVIDIA

Courtesy of Jean-François Méhaut

GPU-friendly Problems

- High arithmetic intensity
 - Computation must offset memory latency
- Coherent data access (e.g. structured grids)
 - Maximize memory bandwidth
- Data-parallel processing
 - Same computation over large datasets (SIMD)
 - E.g. convolution using a fixed kernel, PDEs
 - Jacobi updates (isolate data stream read and write)

GPU : Highly Parallel Coprocessor

- GPU as a coprocessor that
 - Has its own DRAM memory
 - Communicate with host (CPU) through bus (PCIx)
 - Runs many threads in *parallel*
- GPU threads
 - GPU threads are extremely lightweight (almost no cost for creation/context switch)
 - GPU needs at least several thousands threads for full efficiency

Programming Model: SPMD + SIMD

- Hierarchy
 - Device = Grids
 - Grid = Blocks
 - Block = Warps
 - Warp = Threads
- Single kernel runs on multiple blocks (SPMD)
- Single instruction executed on multiple threads (SIMD)
 - Warp size determines SIMD granularity (G80 : 32 threads)
- Synchronization within a block using shared memory

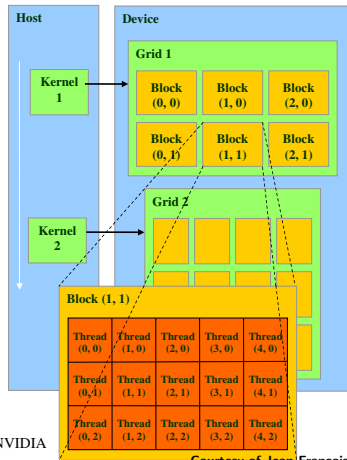

Courtesy NVIDIA

Courtesy of Jean-François Méhaut

Hardware Implementation : a set of SIMD Processors

- Device
 - a set of multiprocessors
- Multiprocessor
 - a set of 32-bit SIMD processors

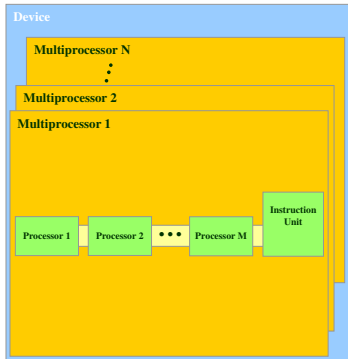

Courtesy NVIDIA

Courtesy of Jean-François Méhaut

Memory Model

- Each thread can:
 - Read/write per-thread registers
 - Read/write per-thread local memory
 - Read/write per-block shared memory
 - Read/write per-grid global memory
 - Read only per-grid constant memory
 - Read only per-grid texture memory
- The host can read/write global, constant, and texture memory

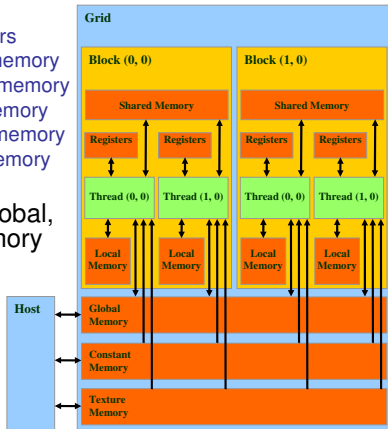

Hardware Implementation : Memory Architecture

- Device memory (DRAM)
 - Slow (2~300 cycles)
 - Local, global, constant, and texture memory
- On-chip memory
 - Fast (1 cycle)
 - Registers, shared memory, constant/texture cache

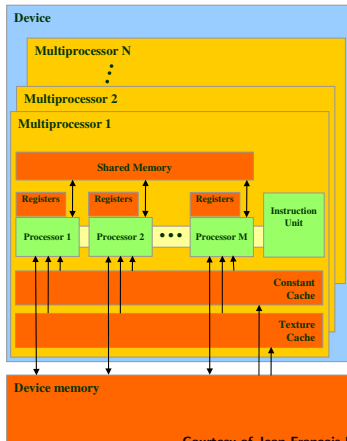

Courtesy NVIDIA

Courtesy of Jean-François Méhaut

Memory Access Strategy

Copy data from global to shared memory

Synchronization

Computation (iteration)

Synchronization

Copy data from shared to global memory

Execution Model

- Each thread block is executed by a single multiprocessor
 - Synchronized using shared memory
- Many thread blocks are assigned to a single multiprocessor
 - Executed concurrently in a time-sharing fashion
 - Keep GPU as busy as possible
- Running many threads in parallel can hide DRAM memory latency
 - Global memory access : 2~300 cycles

CUDA

- C-extension programming language
 - No graphics API
 - Flattens learning curve
 - Better performance
 - Support debugging tools
- Extensions / API
 - Function type : `__global__`, `__device__`, `__host__`
 - Variable type : `__shared__`, `__constant__`
 - `cudaMalloc()`, `cudaFree()`, `cudaMemcpy()`,...
 - `__syncthread()`, `atomicAdd()`,...
- Program types
 - *Device* program (kernel) : run on the GPU
 - *Host* program : run on the CPU to call device programs

Compiling CUDA

- **nvcc**
 - Compiler driver
 - Invoke cudacc, g++, cl
- **PTX**
 - Parallel Thread eXecution

```
ld.global.v4.f32  {$f1,$f3,$f5,$f7}, [$r9+0];
mad.f32          $f1, $f5, $f3, $f1;
```

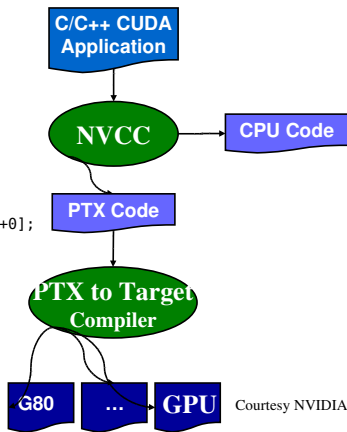

Courtesy NVIDIA

Target code

Courtesy of Jean-François Méhaut

Outline

Parallel Architectures

A. Legrand

Killer applications

Computers must be Parallel

Moore

Power Saving

Memory Limit

Conclusion

Concurrency Within a CPU

Pipelining

ILP

Vector Units

Multi-Threading

Concurrency Within a Box

SMP

Multi-cores

Accelerators:

GPU

Concurrency Across Boxes

Clusters

What next?

- 1 Killer applications
- 2 Why All Computers must be Parallel
 - Moore Law and Computing Limits
 - Multiple Cores Save Power
 - The Memory Limit
 - Conclusion
- 3 Concurrency Within a CPU
 - Pipelining
 - Instruction Level Parallelism
 - Vector Units
 - Hardware Support for Multi-Threading
- 4 Concurrency Within a Box
 - SMP
 - Multi-cores
 - Accelerators: GPU
- 5 Concurrency Across Boxes
 - Clusters
 - What next?

Motivation

Parallel Machines

- ▶ Parallel machines are **expensive**.
- ▶ The development tools for workstations are more mature than the contrasting proprietary solutions for parallel computers - mainly due to the **non-standard** nature of many parallel systems.

Workstation evolution

- ▶ Surveys show **utilization** of CPU cycles of desktop workstations is typically $< 10\%$.
- ▶ **Performance** of workstations and PCs is **rapidly improving**
- ▶ The communications **bandwidth** between workstations is **increasing** as new networking technologies and protocols are implemented in LANs and WANs.
- ▶ As performance grows, percent utilization will decrease even further! Organizations are reluctant to buy large supercomputers, due to the **large expense** and **short useful life span**.

Parallel Architectures

A. Legrand

Killer applications

Computers must be Parallel

Moore

Power Saving
Memory Limit
Conclusion

Concurrency Within a CPU

Pipelining
ILP
Vector Units
Multi-Threading

Concurrency Within a Box

SMP
Multi-cores
Accelerators: GPU

Concurrency Across Boxes

Clusters
What next?

Towards clusters of workstations

Parallel Architectures

A. Legrand

Killer applications

Computers must be Parallel

Moore

Power Saving

Memory Limit

Conclusion

Concurrency

Within a CPU

Pipelining

ILP

Vector Units

Multi-Threading

Concurrency

Within a Box

SMP

Multi-cores

Accelerators:

GPU

Concurrency

Across Boxes

Clusters

What next?

- ▶ Workstation clusters are **easier to integrate** into existing networks than special parallel computers.
- ▶ Workstation clusters are a **cheap** and readily available alternative to specialized High Performance Computing (HPC) platforms.
- ▶ Use of clusters of workstations as a distributed compute resource is very cost effective - **incremental growth of system!!!**

Definition.

A cluster is a type of parallel or distributed processing system (MIMD), which consists of a **collection of interconnected stand-alone/complete computers** cooperatively working together as a **single, integrated computing resource**.

Definition

A typical cluster

- ▶ A cluster is mainly **homogeneous** and is made of **high performance** and generally rather **low cost** components (PCs, Workstations, SMPs).
- ▶ Composed of a few to hundreds of machines.
- ▶ Network: Faster, closer connection than a typical LAN network; often a **high speed low latency network** (e.g. Myrinet, InfiniBand, Quadrix, etc.); low latency communication protocols; looser connection than SMP.

Typical usage

- ▶ Dedicated computation (rack, no screen and mouse).
- ▶ Non dedicated computation: Classical usage during the day (word, latex, mail, gcc) / HPC applications usage during the night and week-end.

Biggest clusters can be split in several parts:

- ▶ computing nodes;
- ▶ front (interactive) node.
- ▶ I/O nodes;

Parallel Architectures

A. Legrand

Killer applications

Computers must be Parallel

Moore

Power Saving
Memory Limit
Conclusion

Concurrency Within a CPU

Pipelining

ILP

Vector Units
Multi-Threading

Concurrency Within a Box

SMP

Multi-cores
Accelerators: GPU

Concurrency Across Boxes

Clusters

What next?

A few examples

Parallel Architectures

A. Legrand

Killer applications

Computers must be Parallel

Moore

Power Saving

Memory Limit

Conclusion

Concurrency Within a CPU

Pipelining

ILP

Vector Units

Multi-Threading

Concurrency Within a Box

SMP

Multi-cores

Accelerators:

GPU

Concurrency Across Boxes

Clusters

What next?



Berkeley NOW (1997)

- ▶ 100 SUN UltraSPARCs.
- ▶ Myrinet 160MB/s.
- ▶ Fast Ethernet.

A few examples

Parallel Architectures

A. Legrand

Killer applications

Computers must be Parallel

Moore

Power Saving
Memory Limit
Conclusion

Concurrency
Within a CPU

Pipelining
ILP
Vector Units
Multi-Threading

Concurrency
Within a Box

SMP
Multi-cores
Accelerators:
GPU

Concurrency
Across Boxes

Clusters

What next?

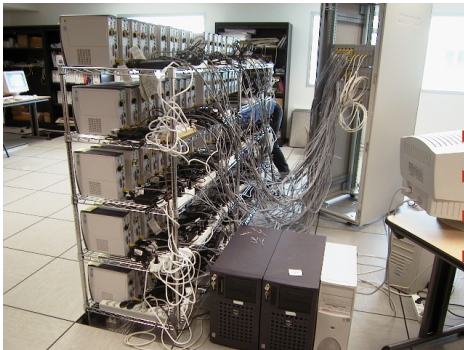

Icluster (2000)

- ▶ 225 HP iVectra PIII 733 Mhz.
- ▶ Fast Ethernet.
- ▶ 81.6 Gflops (216 nodes).
- ▶ top 500 (385) June 2001.

A few examples

Parallel Architectures

A. Legrand

Killer applications

Computers must be Parallel

Moore

Power Saving

Memory Limit

Conclusion

Concurrency

Within a CPU

Pipelining

ILP

Vector Units

Multi-Threading

Concurrency

Within a Box

SMP

Multi-cores

Accelerators:

GPU

Concurrency

Across Boxes

Clusters

What next?

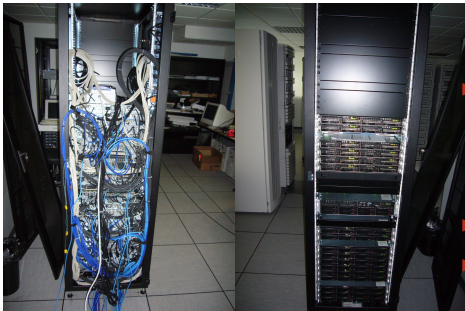

Digitalis (2008)

- ▶ 34 nodes (2 xeon quad cores \rightsquigarrow 272 cores) with $2 \times 8Gb$ of RAM and $2 \times 160Gb$ of HD each.
- ▶ Infiniband.
- ▶ Giga Ethernet.

Clusters of clusters (HyperClusters)

Parallel Architectures

A. Legrand

Killer applications

Computers must be Parallel

Moore

Power Saving
Memory Limit
Conclusion

Concurrency
Within a CPU

Pipelining
ILP
Vector Units
Multi-Threading

Concurrency
Within a Box

SMP
Multi-cores
Accelerators:
GPU

Concurrency
Across Boxes

Clusters
What next?

DAS3: ASCI (Advanced School for Computing and Imaging), Netherlands.

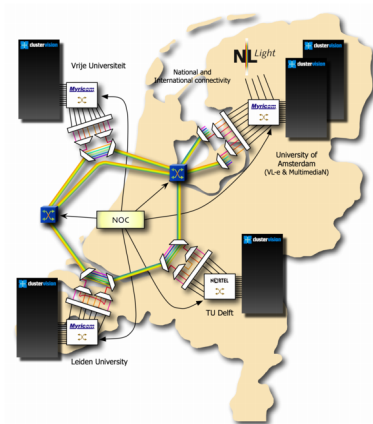

- ▶ Five Linux supercomputer clusters with 550 AMD Opteron processors.
- ▶ 1TB of memory and 100TB of storage.
- ▶ Myricom Myri-10G network inside clusters.
- ▶ Clusters are interconnected by a SURFnet's multi-color optical backbone.

The concept of Grid. . .

Parallel Architectures

A. Legrand

Killer applications

Computers must be Parallel

Moore

Power Saving

Memory Limit

Conclusion

Concurrency Within a CPU

Pipelining

ILP

Vector Units

Multi-Threading

Concurrency Within a Box

SMP

Multi-cores

Accelerators:

GPU

Concurrency Across Boxes

Clusters

Clusters

What next?

The Grid: Blueprint for a New Computing Infrastructure (1998); Ian Foster, Carl Kesselman, Jack Dongarra, Fran Berman,

.....

Analogy with the **electric supply**:

- ▶ You don't know where the energy comes from when you turn on your coffee machine.
- ▶ You don't need to know where your computations are done.

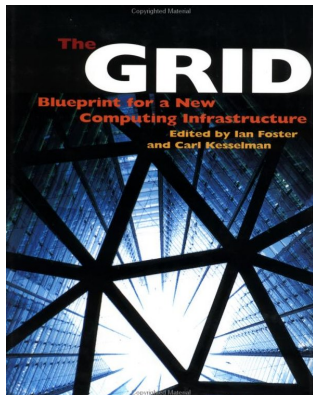

The concept of Grid (cont'd)

Parallel Architectures

A. Legrand

Killer applications

Computers must be Parallel

Moore

Power Saving

Memory Limit

Conclusion

Concurrency

Within a CPU

Pipelining

ILP

Vector Units

Multi-Threading

Concurrency

Within a Box

SMP

Multi-cores

Accelerators:

GPU

Concurrency

Across Boxes

Clusters

What next?

A grid is an infrastructure that couples:

- ▶ **Computers** (PCs, workstations, clusters, traditional supercomputers, and even laptops, notebooks, mobile computers, PDA, and so on);
- ▶ **Software Databases** (e.g., transparent access to human genome database);
- ▶ **Special Instruments** (e.g., radio telescope–SETI@Home Searching for Life in galaxy, Astrophysics@Swinburne for pulsars, a cave);
- ▶ **People** (maybe even animals who knows ?;-)

across the **local/wide-area networks** (enterprise, organizations, or Internet) and presents them as an **unified integrated** (single) **resource**.

What does a Grid look like?

Parallel Architectures

A. Legrand

Killer applications

Computers must be Parallel

Moore

Power Saving

Memory Limit

Conclusion

Concurrency

Within a CPU

Pipelining

ILP

Vector Units

Multi-Threading

Concurrency

Within a Box

SMP

Multi-cores

Accelerators:

GPU

Concurrency

Across Boxes

Clusters

What next?

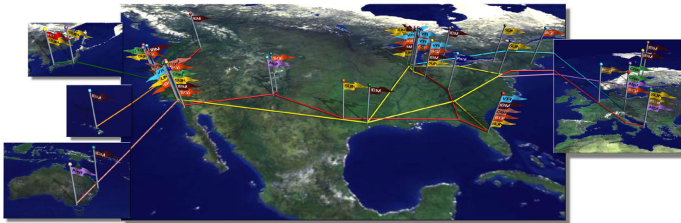

It is very **big** and very **heterogeneous**!

Parallel Architectures

A. Legrand

Killer applications

Computers must be Parallel

Moore

Power Saving

Memory Limit

Conclusion

Concurrency

Within a CPU

Pipelining

ILP

Vector Units

Multi-Threading

Concurrency

Within a Box

SMP

Multi-cores

Accelerators:

GPU

Concurrency

Across Boxes

Clusters

What next?

POOLING IT

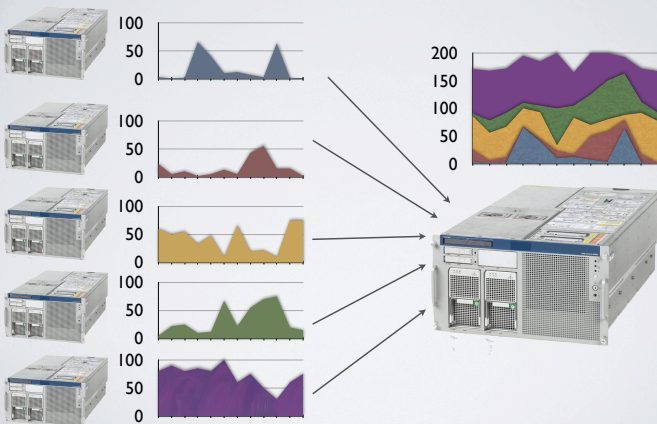

Various versions of “Grid ”

You have probably heard of many *buzzwords*.

- ▶ Super-computing;
- ▶ Global Computing;
- ▶ Internet Computing;
- ▶ Grid Computing;
- ▶ Meta-computing;
- ▶ Cloud Computing;
- ▶ Web Services;
- ▶ Cloud Computing;
- ▶ Ambient computing;
- ▶ Peer-to-peer;
- ▶ Web;

Large Scale Distributed Systems

“A distributed system is a collection of **independent computers** that **appear** to the users of the system as a **single computer**”

Distributed Operating System. A. Tannenbaum, Prentice Hall, 1994

Parallel Architectures

A. Legrand

Killer applications

Computers must be Parallel

Moore

Power Saving

Memory Limit

Conclusion

Concurrency

Within a CPU

Pipelining

ILP

Vector Units

Multi-Threading

Concurrency

Within a Box

SMP

Multi-cores

Accelerators:

GPU

Concurrency

Across Boxes

Clusters

What next?

Tentative taxonomy

Purpose

- ▶ Information: share knowledge.
- ▶ Data: large-scale data storage.
- ▶ Computation: aggregate computing power.

Deployment model

- ▶ Not necessarily fully centralized.
- ▶ Use of **cache**s and **proxy**s to reduce **congestion**.
- ▶ Hierarchical structure is often used.
- ▶ **Centralized** information

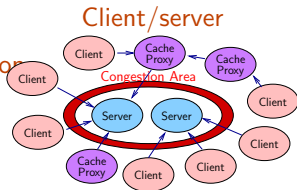

- ▶ Each peer acts both as a client and a server.
- ▶ The load is distributed over the whole network.
- ▶ **Distributed** information.

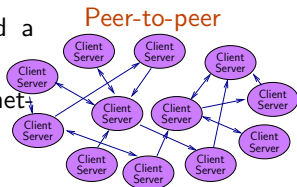

Example: Web sites

Client/server; information grid

Parallel Architectures

A. Legrand

Killer applications

Computers must be Parallel

Moore

Power Saving

Memory Limit

Conclusion

Concurrency

Within a CPU

Pipelining

ILP

Vector Units

Multi-Threading

Concurrency

Within a Box

SMP

Multi-cores

Accelerators:

GPU

Concurrency

Across Boxes

Clusters

What next?

Context

- ▶ Probably the first “grid”.
- ▶ Information is accessed through a URL or more often through a **search engine**.
- ▶ Information access is fully transparent: you generally don't know where the informations comes from (mirrors, RSS feeds,...).

Challenges Going peer-to-peer ? Web 2.0: users also contribute.

- ▶ Social networks (Facebook).
- ▶ Recommendations (google and amazon.com).
- ▶ Crowdsourcing (wikipedia, marmiton).
- ▶ Video and photo sharing (youtube).
- ▶ Media improvement (e.g., linking picassa and google maps).
- ▶ Ease of finding relevant information and ability to tag data.

Example: Napster

Client/server; data grid

Parallel Architectures

A. Legrand

Killer applications

Computers must be Parallel

Moore

Power Saving

Memory Limit

Conclusion

Concurrency

Within a CPU

Pipelining

ILP

Vector Units

Multi-Threading

Concurrency

Within a Box

SMP

Multi-cores

Accelerators:

GPU

Concurrency

Across Boxes

Clusters

What next?

Context

- ▶ The first massively popular “peer-to-peer” file (MP3 only) sharing system (1999).
- ▶ Central servers maintain indexes of connected peers and the files they provide.
- ▶ Actual transactions are conducted directly between peers.

Drawbacks

- ▶ More client/server than truly peer-to-peer.
- ▶ Hence, servers have been attacked (by courts and by others to track peers offering copyrighted materials).

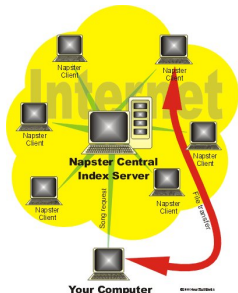

Example: Gnutella, Kazaa, Freenet, Chord

P2P; data grid

Context

- ▶ Removal of servers: searching can be done by **flooding** in **unstructured** overlays.
- ▶ Use of **supernodes**/ultrapeers (nodes with a good CPU and high bandwidth) for searching.
- ▶ **Structured** (hypercubes, torus, ...) overlay networks.
- ▶ Downloading from multiple sources using hash blocks and redundancy.

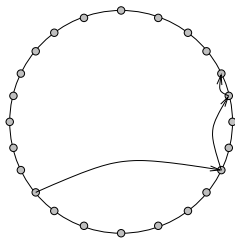
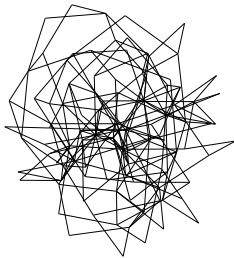

Parallel Architectures

A. Legrand

Killer applications

Computers must be Parallel

Moore

Power Saving
Memory Limit
Conclusion

Concurrency Within a CPU

Pipelining
ILP
Vector Units
Multi-Threading

Concurrency Within a Box

SMP
Multi-cores
Accelerators: GPU

Concurrency Across Boxes

Clusters
What next?

Example: Gnutella, Kazaa, Freenet, Chord

P2P; data grid

Context

- ▶ Removal of servers: searching can be done by **flooding** in **unstructured** overlays.
- ▶ Use of **supernodes**/ultrapeers (nodes with a good CPU and high bandwidth) for searching.
- ▶ **Structured** (hypercubes, torus, ...) overlay networks.
- ▶ Downloading from multiple sources using hash blocks and redundancy.

Challenges

- ▶ Ensuring **anonymity**.
- ▶ Ensuring good throughput and **efficient** multi-cast (network coding, redundancy).
- ▶ Avoiding **polluted** data.
- ▶ Publish-subscribe overlays for **fuzzy or complex queries**.
- ▶ **Free-riders**.

Parallel Architectures

A. Legrand

Killer applications

Computers must be Parallel

Moore

Power Saving
Memory Limit
Conclusion

Concurrency Within a CPU

Pipelining

ILP

Vector Units
Multi-Threading

Concurrency Within a Box

SMP

Multi-cores

Accelerators: GPU

Concurrency Across Boxes

Clusters

What next?

Example: Internet Computing (SETI@home)

Client/server; computation grid

Context

- ▶ Search for possible evidence of radio transmissions from extraterrestrial intelligence using data from a telescope.
- ▶ The client is generally embedded into a **screensaver**.
- ▶ The **server** distributes the work-units to **volunteer** clients.
- ▶ Attracting volunteers with hall of fame and teams.
- ▶ Need to **cross-check** the results to detect false positives.
- ▶ 5.2 million participants worldwide, over two million years of aggregate computing time since its launch in 1999. **528 Ter-aFLOPS** (Blue Gene peaks at just over 596 TFLOPS with sustained rate of 478 TFLOPS).
- ▶ Evolved into **BOINC**: Berkeley Open Infrastructure for Network Computing (climate prediction, protein folding, prime number factorizing, fight cancer, Africa@home, ...).

Parallel Architectures

A. Legrand

Killer applications

Computers must be Parallel

Moore

Power Saving

Memory Limit

Conclusion

Concurrency

Within a CPU

Pipelining

ILP

Vector Units

Multi-Threading

Concurrency

Within a Box

SMP

Multi-cores

Accelerators:

GPU

Concurrency

Across Boxes

Clusters

What next?

Example: Internet Computing (SETI@home)

Client/server; computation grid

Parallel Architectures

A. Legrand

Killer applications

Computers must be Parallel

Moore

Power Saving

Memory Limit

Conclusion

Concurrency

Within a CPU

Pipelining

ILP

Vector Units

Multi-Threading

Concurrency

Within a Box

SMP

Multi-cores

Accelerators:

GPU

Concurrency

Across Boxes

Clusters

What next?

Challenges

- ▶ **Attract more volunteers:** credits, ribbons and medals, connect with facebook.
- ▶ **Volunteer thinking:** use people's brains (intelligence, knowledge, cognition) to locate' solar dust, fossils, fold proteins.
- ▶ Works well for **computation intensive embarrassingly parallel** applications.
 - ▶ Really parallel applications.
 - ▶ Data intensive applications.
 - ▶ Soft real-time applications.
- ▶ **Security.**
 - ▶ Would you let anyone execute anything on your PC?
 - ▶ Use sandboxing and virtual machines.
- ▶ Need to go peer-to-peer (OurGrid).

Example: Meta-computing

Client/server; computation grid

Parallel Architectures

A. Legrand

Killer applications

Computers must be Parallel

Moore

Power Saving

Memory Limit

Conclusion

Concurrency

Within a CPU

Pipelining

ILP

Vector Units

Multi-Threading

Concurrency

Within a Box

SMP

Multi-cores

Accelerators:

GPU

Concurrency

Across Boxes

Clusters

What next?

Context

- ▶ Principle: buy computing services (pre-installed applications + computers) on the Internet.
- ▶ Examples: Netsolve (UTK), NINF (Tsukuba), DIET and Scilab // (ENS Lyon/INRIA),



Challenges

- ▶ **Data storage and distribution:** avoid multiple transfers between clients and servers when executing a sequence of operations.
- ▶ Efficient **data redistribution**.
- ▶ **Security** for file transfers
- ▶ Peer-to-peer deployment.

Example: grid computing

Client/server; computation grid; cloud computing

Context

- ▶ Principle: use a *virtual supercomputer* and execute applications on remote resources.
“I need 200 64 bits machines with 1Tb of storage from 10:20 am to 10:40 pm.”
- ▶ Need to **match** and **locate** resources, **schedule** applications, handle **reservations**, **authentication**, ...
- ▶ Examples: Globus, Legion, Unicore, Condor, ...

Challenges

- ▶ Obtaining good performances while deploying **parallel codes on multiple domains**.
- ▶ Communication and computation overlap. High-performance communications on **heterogeneous networks**.
- ▶ Need for new parallel algorithms that handle **heterogeneity**, **hierarchy**, **dynamic resources**,
- ▶ Complex applications \rightsquigarrow **code coupling** (message passing \rightsquigarrow distributed objects, **components**).

Parallel Architectures

A. Legrand

Killer applications

Computers must be Parallel

Moore

Power Saving
Memory Limit
Conclusion

Concurrency Within a CPU

Pipelining
ILP
Vector Units
Multi-Threading

Concurrency Within a Box

SMP
Multi-cores
Accelerators: GPU

Concurrency Across Boxes

Clusters
What next?

Summary

Usage \ Deployment	Client/Server	Peer-to-peer
Data	Napster	Gnutella, Kazaa, Chord, Freenet. . .
Information	Web 1.0 and 1.5 Search Engines	Web 2.0
Computing	Internet Computing; Meta-computing; Grid Computing	OurGrid

A few other challenges

- ▶ Security, Authentication, Trust, Error management.
- ▶ Middleware vs. Operating System.
- ▶ Algorithms for Grid Computing.
- ▶ Software engineering.
- ▶ Social aspects (fairness, selfishness, cooperation).
- ▶ Energy saving!
- ▶ Failures...

Parallel Architectures

A. Legrand

Killer applications

Computers must be Parallel

Moore

Power Saving
Memory Limit
Conclusion

Concurrency Within a CPU

Pipelining

ILP

Vector Units
Multi-Threading

Concurrency Within a Box

SMP

Multi-cores

Accelerators:
GPU

Concurrency Across Boxes

Clusters

What next?

Calcul hautes performances

Évolution du MTBF dans le futur

1 PetaFlop =
200k 5Gflop CPU

Avec du matériel fiable actuel (ASCI white), une machine de cette dimension subit

1 défaillance par heure

MTBF système (heures)

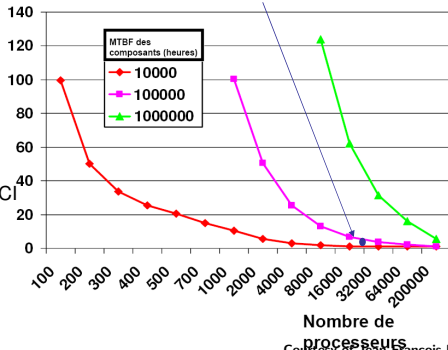

Conclusion

Parallel Architectures

A. Legrand

Killer applications

Computers must be Parallel

Moore

Power Saving
Memory Limit
Conclusion

Concurrency Within a CPU

Pipelining

ILP

Vector Units
Multi-Threading

Concurrency Within a Box

SMP

Multi-cores

Accelerators:
GPU

Concurrency Across Boxes

Clusters

What next?

- ▶ No real new theme but rather a combination of already existing technologies for parallel and distributed computing.
- ▶ Such combinations and ambitious goals are very hard to achieve.
- ▶ This clearly requires a **pluri-disciplinary approach** with a good understanding of all aspects (OS, network, middleware, security, storage, algorithms, applications, ...).
- ▶ It would be a mistake to restrict only to computing. Research on all these aspects should be encouraged.
- ▶ It is very important to identify and discriminate new concepts from technology and fad.
- ▶ A crucial question is:

“Should we hide the complexity or expose it?”

Tunnel Vision by Experts

- “On several recent occasions, I have been asked whether parallel computing will soon be relegated to the trash heap reserved for promising technologies that never quite make it.”
 - Ken Kennedy, CRPC Directory, 1994
- “640K [of memory] ought to be enough for anybody.”
 - Bill Gates, chairman of Microsoft, 1981.
- “There is no reason for any individual to have a computer in their home”
 - Ken Olson, president and founder of Digital Equipment Corporation, 1977.
- “I think there is a world market for maybe five computers.”
 - Thomas Watson, chairman of IBM, 1943.